

Windows & Doors by Internorm

Europe's No. 1 Window Brand

Nothing compares to

Internorm[®]
Windows – Doors

2025/2026

Timber-Aluminium Windows
Page 52



uPVC & uPVC-Aluminium Windows
Page 38



Internorm innovations
Page 16

Lift & Slide Doors and Fixed Glazing
Page 70



Renovations
Page 24



Entrance Doors
Page 78

Contents

COMPANY	4
Our Values	4
Production	6
Service	8
Warranty	9
Sustainability	10
INNOVATIONS	14
I-tec Technologies	16
RENOVATIONS	22
WINDOWS	34
Design Styles	34
uPVC & uPVC-Aluminium Windows	36
Timber-Aluminium Windows	50
Windows with integrated Blinds	62
Lift & Slide Doors and Fixed Glazing	70
COMBINATIONS	76
ENTRANCE DOORS	78
Design Options	80
Door Systems	82
Door Series	84
Side Entrance Doors	102
FINISHES & ACCESSORIES	104
Colours	106
Handles	108
Glass	114
Online Door Designer	116
Juliet Balcony	118
Security	119
Sun Protection and Flyscreens	124
Technical Overview	130
Certifications	134





Internorm – Europe’s No. 1 Window Brand

Internorm has been a family business for 94 years. Since its beginnings as a one-man locksmith, it has developed into the biggest window brand, operating on an international scale.

More than 29 million window and door units – 100% made in Austria – have so far made their way to new homes from our three production facilities in Traun, Sarleinsbach and Lannach. From the early beginnings of the uPVC window and the first timber-aluminium windows, to today’s high-tech and contemporary design innovations, our family company still sets the standard across Europe and beyond. Our focus on continuous technological developments and innovative solutions has made us the pioneers of the fenestration industry.

We employ over **2,100 employees** throughout Europe, all of them specialists within their field, who work with dedication, creativity and attention to detail. Together with over **1,300 distribution partners in 21 countries**, we strive to deliver a quality product and competent customer service.

Now in the hands of the third generation, **Anette Klinger**, **Stephan Kubinger** and **Christian Klinger** are leading the company with a strong focus on stability and sustainability. Their drive and commitment to innovation ensures that the company continues to be the trailblazer within the window and door industry.



100% quality made in Austria – that's what we stand for.

Our experienced employees create your bespoke windows and doors in our three high-tech manufacturing sites in Austria – Traun, Sarleinsbach and Lannach. Every window or door is unique.

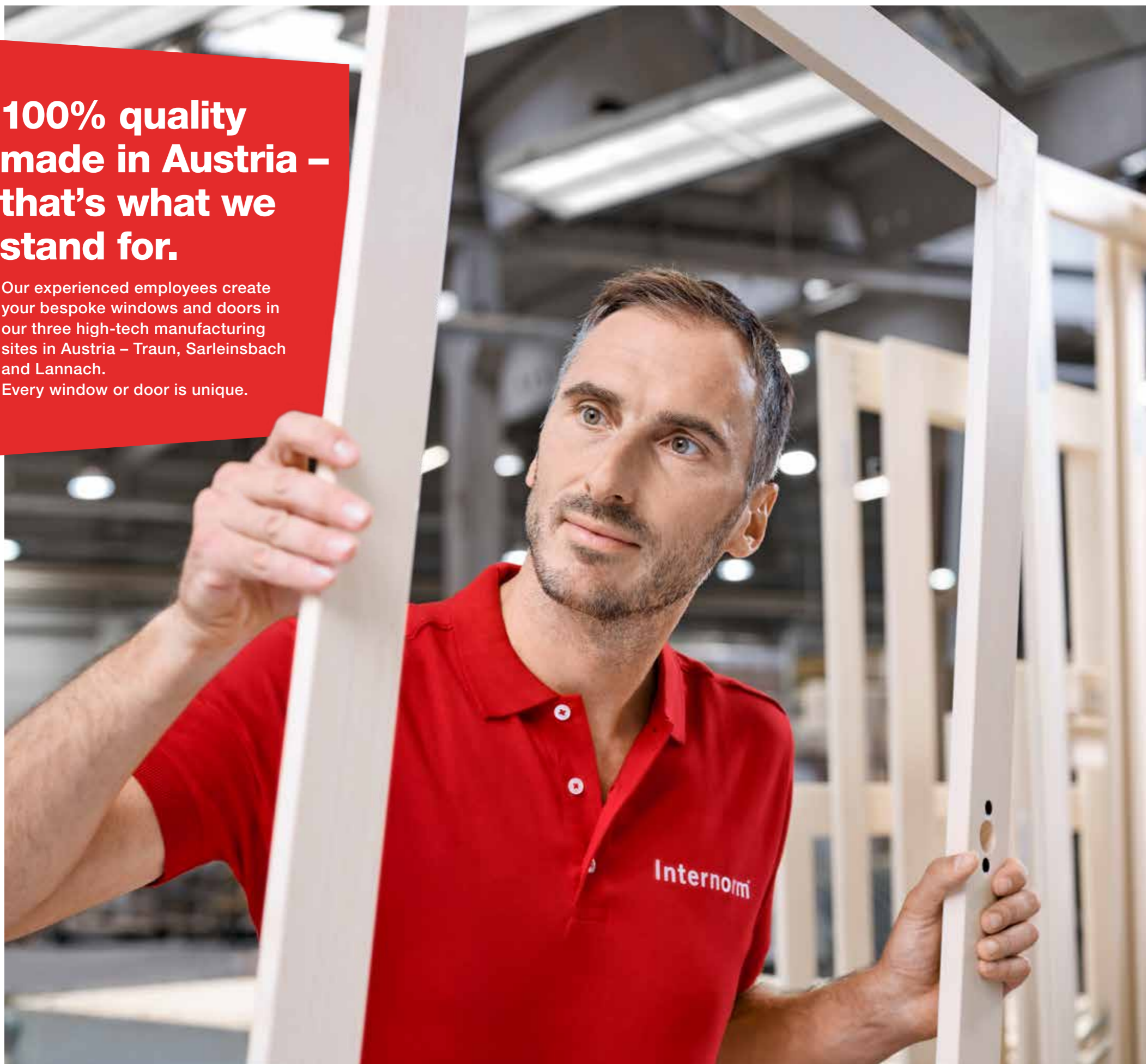

Outstanding quality is the result of our passion.



Our employees are specialists with an eye for detail, who carry out their jobs with passion and creativity. The company's own research department is continuously developing new products and technologies to provide you with even more comfort and security. Our production employees work with the greatest care to create quality products for modern living. We focus on sustainable, energy-efficient and safe production processes to ensure the preservation valuable resources.



A unique QR code on your windows and entrance doors

This reveals a special service to give your windows and doors a long life.

By scanning the QR code in the rebate of your window or aluminium entrance door, you will receive **useful information on your product**, helpful tips on cleaning, contact details for your responsible distribution partner, as well as a link to the online shop for maintenance products. To ensure the longevity of your windows and doors, your Internorm products require the **correct care and maintenance**. You can find all the relevant information on this, as well as suitable replacement parts from the Internorm window service at www.fensterservice.com or from **your distribution partner**.



Our guarantee also demonstrates responsibility.

As the largest, leading European window brand, operating internationally, Internorm boasts over 93 years of experience and is focused on developing innovative, exceptionally high-quality and reliable window and door solutions. That's our guarantee.

Warranty

10 YEARS

- On weather resistance against unnatural discolouration and against the formation of cracks in surfaces of white uPVC window and door profiles, except for mitre cracks
- On weather resistance against unnatural discolouration and against the formation of cracks in surfaces of white uPVC window and door profiles with foil coating on the inside, except for mitre cracks
- On weather resistance against unnatural discolouration and against the formation of cracks in surfaces of anodised or powder-coated window and door profiles made of aluminium
- Against condensation between the sealed panes of insulating glass
- On the function of the material compound timber, thermal foam and aluminium profiles in all Internorm timber-aluminium window systems when adhering to the Internorm fitting and maintenance guidelines
- On the function of the glued connection and waterproofing of the insulating glass panes with window profiles in all Internorm timber-aluminium window systems when adhering to the Internorm fitting and maintenance guidelines
- On the gluing of stick-on glazing bars

Warranty

5 YEARS

- On corrosion of PVD-coated entrance door handles, if no mechanical damage is apparent.
- On weather resistance against unnatural discolouration or the formation of cracks in door panel surfaces (SD10 Real wood excluded) No warranty is given in the event of changes of the surface appearance as a result of soiling.

Warranty

3 YEARS

- On weather resistance against unnatural discolouration and against the formation of cracks in surfaces of uPVC roller shutter profiles.
- On weather resistance against unnatural discolouration and against the formation of cracks in surfaces of anodised or powder-coated roller shutter and blind profiles made of aluminium
- On the function of window and door hardware when the Internorm fitting and maintenance guidelines have been followed

Guarantee

30 YEARS

Furthermore, Internorm guarantees that Internorm products can be serviced repeatedly by our experts (original parts not required) to ensure that their full functionality is ensured or maintained for a period of 30 years – however, the prerequisite for this is that the frame construction (frame and sash) are free from damage. The 30-year period starts from the date of production. Electronic components are excluded. If the system is too worn or damaged, it may only be possible to replace the affected element. The servicing or materials, working hours, etc. required to maintain functionality are billed in accordance with the applicable rates.

Warranties/excerpt: The full version of our warranty information, warranty requirements and how to make a warranty claim can be found in the Internorm Maintenance, Care and Warranties Manual. This manual is delivered together with your Internorm products. It is also available as a PDF from the Download section of our website and from every **Internorm 1st** window partner.

Internorm takes responsibility

Internorm

Responsibility for the environment and climate



Highest quality and durability

By developing and producing state-of-the-art products that meet the highest quality standards and offer outstanding durability, we are making a valuable contribution to protecting the environment and our climate. Our in-house development and testing centre not only subjects these high quality products to rigorous testing, but also ensures their continuous development. This allows us to offer above-average guarantees and excellent services, including a 30-year repair assurance. You clearly benefit as a result – and so do our environment and climate.



Maximum energy efficiency for reduced heating costs

Internorm offers a wide range of products that feature the highest possible level of thermal insulation. This not only maximises the energy efficiency of your property, but also significantly reduces your heating costs. Over 900,000 satisfied Internorm window renovation customers are already benefiting from this reduction in energy costs, while at the same time contributing significantly to protecting our environment and climate.



Sustainable product design

We ensure that sustainability remains at the forefront of our efforts during product development. We therefore utilise materials that have a high recycled content and reduced carbon footprint. In particular, we use a special type of low-carbon glass which generates some 45% less CO₂ during manufacture than standard float glass. Moreover, its use in our products saves over 10,000 tonnes of CO₂ annually. Our uPVC windows can also be recycled up to seven times. The materials can therefore be reused in the next generation of windows, helping conserve valuable resources.



Environment and climate-friendly production

Internorm is synonymous with efficient, environment and climate-friendly production – 100% made in Austria. By using green electricity and installing photovoltaic systems at all our production sites – producing a total of 3,300 kWp – we are maximising the share of energy generated from renewable sources and in-house PV. By continuously optimising our production processes, we are minimising our consumption of materials, energy and water, and reducing the amount of waste we produce.

Internorm's use of low-carbon iplus glass saves 10,000 t of CO₂ eq annually

Based on the widespread adoption of this low-carbon thermally insulated glass and projected to our total window production in 2025.

Glass is a fundamental component in window production. As Europe's leading window brand, we take our responsibility seriously, and incorporate **low-carbon iplus insulating glazing** in our product range as standard.

In order to reduce greenhouse gas emissions, we analysed the entire low-carbon float glass production chain. This included activities before, during and after the actual manufacturing process, right through to delivery to the customer. **The result is a 4 mm thick, low-carbon float glass with a reduced carbon footprint of 5.5 kg CO₂ eq/m²** that delivers emission savings of over 45%.**

Projected to the year 2025, using low-carbon iplus thermal glazing equates to CO₂ eq savings of some 10,000 tonnes compared to standard iplus glazing. This corresponds to 1,782 circumnavigations of the earth in a mid-range car (with average CO₂ emissions of 140 g/km).

Carbon footprint

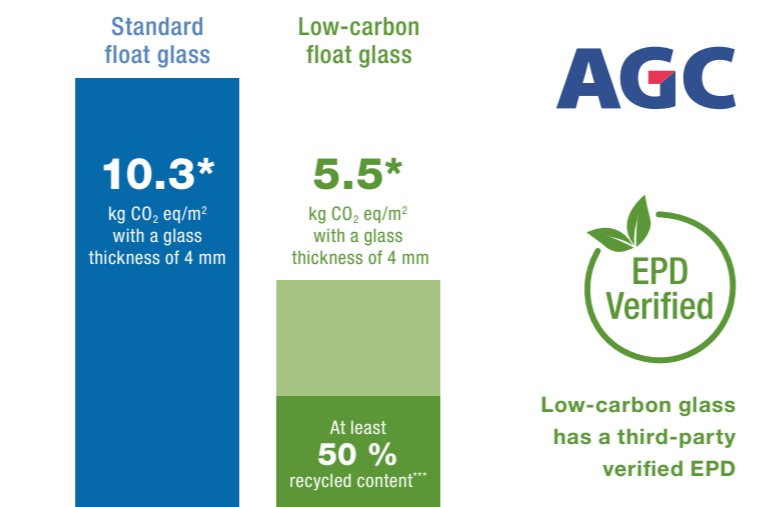

AGC values that are to be considered within the following framework:
 * Global Warming Potential (GWP) is given for cradle-to-gate (A1-A3) impacts as defined in NF EN 15804+A2:2019. EPD Planibel Clearlite 8 mm – Registration number: 20240940452-FC (publicly available in the INIES database)
 ** The global warming potential (GWP) is given for the cradle-to-gate impact (A1-A3) as defined in NF EN 15804+A2:2019. EPD Low-Carbon Planibel Clearlite registration number: 20240940455-FC (publicly available in the INIES database)
 *** Calculated in accordance with ISO 14021:2016

What turns low-carbon iplus glass into thermally insulated glass?



Example: Standard triple-glazed thermal glass with two coatings

FACT|BOX

- Low-carbon iplus thermally insulated glass with a reduced carbon footprint of just 5.8 kg CO₂ eq/m² (Low-carbon float glass 5.5 kg CO₂ eq/m²)
- Standard in all Internorm products
- Significant improvement in the carbon footprint to benefit humans and the environment

Low-carbon iplus thermal insulation coating
 The iplus coating on thermal glass is well protected within the space between the outer and inner panes of the glass unit.



- Use of low-emission raw materials
- Use of highly efficient melting furnaces including electric boosting
- At least 50% recycled content, to conserve valuable raw materials
- Utilisation of renewable energies
- Optimised transport throughout the entire supply chain



Our innovations

The innovative and modern windows and doors produced by Internorm combine technology, longevity and design in a very unique way.

I-tec Secure

I-tec Secure locking technology – state-of-the-art design meets maximum security

Unrivalled, fully integrated locking mechanism up to resistance class RC 3



Smooth finish for a sleek look and easy cleaning

It's not just the people who surround us, but also the way we furnish our living spaces, and our view of the outside, that help us feel at home in our own four walls. A sense of security is another important component.



The flaps also offer considerable advantages when it comes to cleaning the windows. Only a few parts protrude from the sash, while the frame parts are concealed almost entirely, leaving a smooth, easy-to-clean uPVC surface.

With the unrivalled I-tec Secure locking mechanism, you can rest assured that your windows offer reliable protection. Instead of the usual locking pins, flaps are used to precisely lock the window sash into the frame. It is virtually impossible to lever out the window.

I-tec Secure is integrated into our KF 510 and KF 520 premium-design uPVC-aluminium windows as standard and is available up to resistance class RC 3 on request. Both window systems are available in uPVC and uPVC-aluminium options, and achieve security rating RC 2 N as standard with the optional lockable handle.



Learn more about our unrivalled I-tec Secure locking mechanism.



Standard distribution of the I-tec Secure locking points

FACT|BOX

- Modern glass architecture with slim sightlines
- Elegant design without visible hardware
- Optimum security up to RC 3 achieved by integrated flaps
- Virtually impossible to lever out the window
- Easy-to-clean window frame

Our I-tec innovations

Internorm **I-tec innovations** are a series of revolutionary and industry-leading technologies for windows and doors.

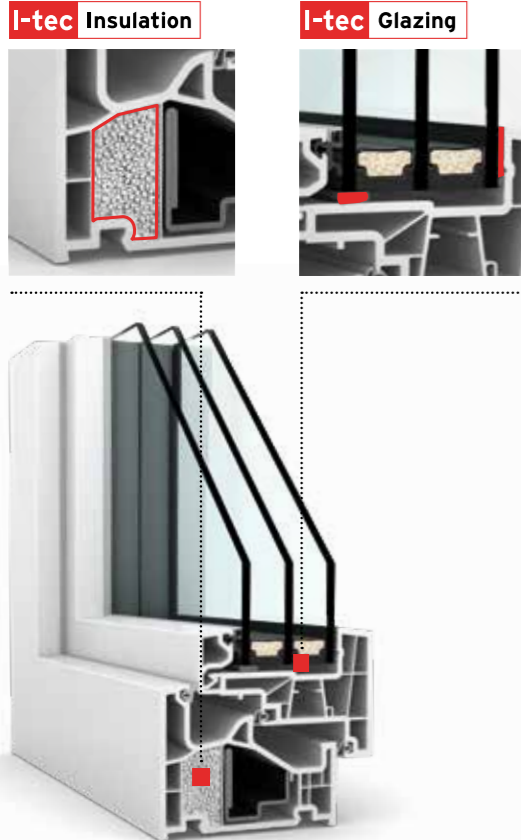

I-tec Insulation

Innovative window insulation

I-tec Insulation is included as standard with three Internorm window systems: the KF 410, KF 510, as well as our KV 440 windows with integrated blinds. Granulate is pushed into the frame's interior with pressure, thereby evenly filling the surrounding hollow chambers. This considerably improves thermal insulation.

I-tec Glazing

All-round bonding

I-tec Glazing technology provides maximum stability and security for your home. The glass pane is glued along the entire periphery of the window sash. This unique adhesive system guarantees firm bonding between glass and sash and considerably improves stability, thermal insulation and sound reduction.

I-tec Shading I-tec Connect



I-tec Shading

Energy self-sufficient sun protection

With its photovoltaic module and back-up battery pack, I-tec Shading provides the ideal room temperature – it is completely self-sufficient, without requiring an additional energy supply.

When set to automatic mode, the Venetian blinds open and close automatically. Controlled by a built-in temperature sensor, it allows you to maximise the use of sunlight in winter, therefore reducing heating costs.

I-tec Connect

With I-tec Connect, Internorm has produced intelligent products that are Smart Home-ready. To integrate I-tec Shading into common Smart Home systems, all you need is a small device that can be purchased from one of our sales partners. Using this bridge, I-tec Shading can be controlled via the Matter wireless standard with compatible smart home systems such as Amazon Alexa, Google Home, Apple HomeKit or Samsung SmartThings.



Scan here to find out more about I-tec Shading.

Internorm

Daily convenience with I-tec Open

Simply knock to open – thanks to the modern day latch function for your entrance door.



Knock-knock

Knock twice on the outside of the door to unlock the door sash, and you'll be able to open the door without much effort – as easy as child's play. Knocking creates vibrations that activate the module, which is installed out of sight within the frame. You don't need to knock on a particular area of the door. The I-tec Open technology prevents the door from opening accidentally, for example by gusts of wind, as only knocking can create the required vibrations.



I-tec Open

FACT|BOX

- Easy activation using a push button (fingernail-friendly)
- Modern, electronic day latch function
- Children, weaker persons or even wheel-chair users can enter more easily and without great effort
- Unintended opening by a gust of wind or draft is not possible



A green light on the switch lets you know quickly and clearly whether the day latch is activated. If the light isn't on, this means that the module is deactivated and the day latch function is not in operation.

I-tec Open is **fully integrated into the door frame** and not visible from the outside.

Note: If I-tec Open is controlling the electric door opener (see ETOE, page 123) – the door may not be locked.



I-tec Décor Oak natural



FACT|BOX

- The exciting digital printing technology of the future
- Eleven different designs offer individual creative options
- Available as internal finish on uPVC for KF 310 and KF 410 windows, and KS 430 lift & slide door

I-tec Décor

The technology of the future Digital printing now at Internorm

New design options for maximum individuality

With the new I-tec Décor, the surfaces of your internal window profiles can be matched to your furniture, floors or doors. The new digital printing technology works in a similar way to an inkjet printer, allowing you to create a more personalised, unique home.

The I-tec Décor design is applied in multiple layers to the internal uPVC profile. An additional top coat provides protection against UV radiation and commercially available cleaning agents. With the new I-tec Décor digital printing technology, we can offer eleven distinct designs on the inside of KF 310, KF 410 and KS 430 systems, which will blend beautifully into your interior design.

Internorm



I-tec Décor
Oak natural



I-tec Décor
Concrete grey



I-tec Décor
Walnut natural



I-tec Décor
Oak white



I-tec Décor
Oak grey



I-tec Décor
Oak black grey



I-tec Décor
Oak olive grey



I-tec Décor
Oak light



I-tec Décor
Oak tobacco



I-tec Décor
Walnut red



I-tec Décor
Spruce natural

Details on colour and texture can be found in our colour overview (page 107).



Reduce your energy costs by renovating with Internorm.

When renovating with our quality, high-performance windows and doors, you make a sustainable investment in your future. They provide energy efficiency, reduce heating costs, improve home comfort, and protect the climate.

Add value to your home

Making something good even better



5 good reasons to renovate your home

The initial investments in replacing your windows or entrance door may seem high at first, however, these purchases are of lasting value that quickly pay for themselves. The comfort within your home is greatly improved and the value of your property is significantly increased.

1. Cost savings & energy efficiency

New windows and doors reduce energy consumption and therefore heating costs. Lower energy consumption not only has a positive effect on ongoing energy costs, but also makes a key contribution to climate protection.

2. Home comforts

Stylish, high-performance windows and doors that match your interior décor create a comfortable atmosphere and enhance your quality of life. An optimised indoor climate means that it warms up more quickly in winter, remains pleasantly cool in summer and banishes uncomfortable draughts.

3. Added value enhancement & upgrading

A renovation not only increases the value of your property, it also increases the feeling of well-being and comfort within your own four walls.

4. Full-service package delivered with care

Our sales partners' installers carry out replacements quickly and professionally. There is no reason to be deterred from replacing your windows or entrance door – we take good care of your home.

5. Attractive grants

In many countries there are more renovation grants than ever before. Find out whether you are eligible for any grants to recoup some of your investment costs.











Save sustainably
Efficient and sensible conservation of resources



HARD|FACTS

-  40% of global CO₂ emissions are caused by poorly insulated buildings.
-  40% of European energy consumption is attributable to buildings.
-  25 to 30% of the heat in a building escapes through windows and doors.
-  88% of greenhouse gas emissions from buildings result from private households.
-  Extensive renovation delivers energy savings of up to 76%.
-  In Austria alone, 2.5 million residential units are thermally inadequate.

Cost savings and energy efficiency

Leaky joints, old glazing, draughts, noise and high heating costs: There are many reasons for a renovation. Whether it is a simple window replacement, thermal insulation, or even a complete retrofit, or extension – you will not only have saved on energy costs, but also improved security and living comfort.

Lower heating costs
Up to 30% of heat escapes through old windows. The solution: Quality high-performance triple-glazed, thermally insulated windows from Internorm. These ensure greater energy efficiency and significantly reduce your home's heating costs.

Not all products and manufacturers deliver what they promise. You should therefore trust companies with many years of experience that deliver quality, tested products. Competent and trustworthy advice is just as important as a high-quality, durable product. That's why Internorm only works with approved and qualified partners. They deliver a full-service offering, from

professional consultation, to survey and tidy installation, as well as outstanding after-sales support. We want you to experience a seamless renovation and retrofit.

An investment in a better future.

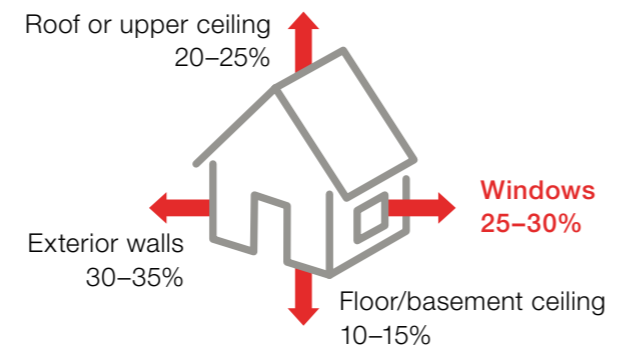

Fig.: Example of transmission heat losses in an average detached house



Home comforts

Transformative retrofit into an energy-efficient, sustainable home



Internorm

“We love the oak interior finish of the windows. They frame the views beautifully in all directions. Whatever the weather or season, the outside looks like an ever-changing painting”.



A new lease of life for a run-down 1960s house

Sitting on top of a hill overlooking the beautiful Kent countryside, it was clear why the owners fell in love with this property. However, the house they encountered during their initial viewing was a neglected 1960s building, with leaking roofs and poorly insulated walls, windows, and doors. It needed complete refurbishment to bring it into the 21st century.

The homeowners spent a long time researching windows and doors. When they compared the thermal performance and cost of other brands to Internorm, they realised that there was no comparison and contacted Internorm distribution partner AT-Eco.

“Living with our Internorm windows and lift & slide doors is a joy! Being on an exposed site, the robust quality of the products means that during fierce winter storms and horizontal rain, our home is quiet, warm, and secure. There are no air gaps to worry about.”

Choosing quality products and local suppliers were important factors in their decision making. They did not seek Passivhaus certification but wanted to renovate to Passivhaus standard to create a green, sustainable home that stood the test of time.

“It feels like a real home. I wanted this house to reflect our personalities and tastes. Quite often, we just sit on the sofa, watch the evenings draw in and just enjoy the amazing view.”



Watch their full Case Study Video

Added value enhancement & upgrading

Traditional Edwardian house gets a face lift



Internorm

“The windows have transformed our property! More light, improvement in sound insulation, and I put a premium on security.”



Back to the future – elegant period home renovation

This period property is a fantastic example of Internorm windows and doors being integrated into more traditional architecture. The original section of this stunning property in Hertfordshire was built in 1904 and extended over time.

The previous golden oak uPVC double glazed windows were replaced by Internorm triple-glazed timber-aluminium windows and doors. Old uPVC bi-folds were changed to large lift & slide doors, which instantly brightened the interior. Overall, the energy-efficiency of the building was greatly improved.

The Internorm windows with Georgian bars now look like the originals from over 100 years ago, but with the benefit of superior performance. This property is situated near a busy road and the triple glazing also made an enormous difference to the noise reduction. A detailed survey was crucial to ensure a successful window replacement. The Internorm installer took great care to ensure there was little to no damage to the expensive interior décor, and the homeowners were delighted by how quickly and efficiently the work was carried out to a very high standard. This property has received a new lease of life, and the homeowners could not have been more delighted with their home renovation.

“Replacing our old windows and bi-fold doors with Internorm triple glazing has increased the value of our home.”

Watch their full Case Study Video





Expert installation

Conscientious and professional

Full-service package delivered with care

A home renovation is a matter of trust. From reputable, expert advice, and choosing the right products for your project, to competent installation. Unlike a new build, you will want as little disruption as possible, as you will most likely be living in your house whilst work is carried out.

Internorm sales partners ensure a seamless installation - you will hardly notice that the window replacement is happening. Once the timing has been jointly agreed, the sales partner will carry out a survey. Windows are measured, and the structural conditions are checked. Our partners place great emphasis on cleanliness when replacing your windows. Surrounding areas are covered up and old windows are carefully removed. The area is left clean and tidy once the installation has been fully completed. On request, your Internorm sales partner will of course also ensure that your old windows and entrance door are properly disposed of.

Internorm prides itself in the outstanding quality of its products and the professionalism of installers. For that reason, Internorm guarantees to go beyond the usual industry standard. The 30-year repair assurance needs to be mentioned. This means that Internorm products can be repaired over a period of three decades to ensure that their full functionality is guaranteed.

A sound investment with all-round service.



Click here for the renovation video

Internorm

1. Uncomplicated

Your Internorm partner will arrive at your home to carry out a survey, to check the structural conditions, measure the windows and develop an exact schedule together with you. Your bespoke windows are then manufactured according to your individual specifications.

2. On time

Your order is delivered complete and on the agreed date.

3. Clean & tidy

We place great emphasis on cleanliness during the renovation work. That's why all surrounding areas are covered, and curtains are removed before work starts.

4. With care

Your old windows are carefully removed. Special care is taken to ensure that the surrounding brickwork is not damaged.

5. Window by window

The windows are replaced in quick succession.

6. Air tight

The correct building connection and connecting joint ensure the necessary air tightness between the window and joints masonry.

7. Cleaned

Once installation is complete, the protective film is removed and the area is cleaned.

8. Checked

The installation team, together with you, checks all windows, to ensure they are fully functional. Finally, we provide you with maintenance and care advice.



Design styles



 **studio minimalist**

For design lovers with a passion for elegance.

The **studio** design style is characterised by clean lines and a minimalist design. Large glazing becomes a design feature in its own right, whilst enhancing exceptional architecture.



 **home pure contemporary**

Simple, straight lines for classic designs.

The modern **home pure** window with its square edge design perfectly blends into the unique architecture of contemporary buildings.



 **home soft harmonious**

Gentle curves for creating feature highlights.

The elegant round-edge design of a **home soft** window creates a sleek and timeless look that can be integrated effortlessly into any design and lends the architecture a particularly harmonious ambience.



 **ambiente traditional**

Classic detailing for timeless architecture.

An **ambiente** window offers the perfect blend of traditional design and classic detailing. The round profiled edges add a unique character to any facade.



Internorm



Our uPVC & uPVC-aluminium windows

We produce and develop innovative windows that satisfy even the highest demands. Whether unrivalled protection against burglary, exceptional thermal insulation or outstanding noise protection – we place great value on meticulous processing down to the last detail.

Premium Design

The **KF 520** and **KF 510** uPVC & uPVC-aluminium windows from Internorm



Standard uPVC-aluminium window Our slim KF 520 aluminium window

Particularly slim and modern thanks to slim sightlines, the increased areas of glazing allows for maximum light penetration and comfort of living.



The **highly weather-resistant aluminium coating** from Internorm increases colour stability.

I-tec Secure



The **fully integrated I-tec Secure locking system** not only provides maximum security, but also offers easy cleaning. This locking system is **only available from Internorm** and is integrated into the KF 520 and KF 510 windows as standard.

Internorm

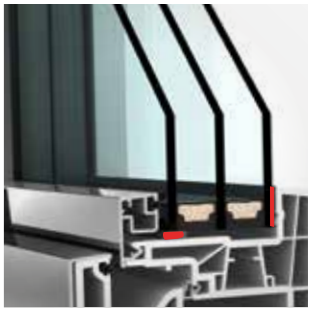

I-tec Glazing

The all-round bonding of the glass pane with the window provides **outstanding stability** and **protection against break-ins**. It also increases thermal insulation and sound reduction.



The **high-quality handles** are available in a number of options and colours. You'll find a suitable window handle for every design.



Three circumferential gaskets, made of high-quality, durable materials, keep water out and improve thermal insulation and sound reduction.

I-tec Insulation

The **insulating granules** are evenly distributed throughout the hollow chambers, thereby improving thermal insulation in our KF 510 and KF 410 window systems, as well as our KV 440 windows with integrated blinds.

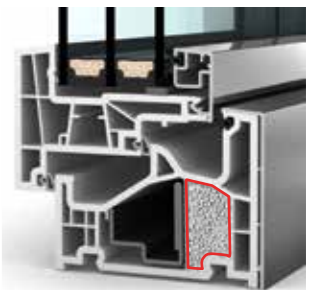

KF 520

uPVC & uPVC-aluminium windows



I-tec Secure

I-tec Glazing

 **Thermal insulation**
U_w as low as = 0,63 W/(m²K)

 **Noise reduction**
up to 46 dB

 **Security**
up to RC 3

 **Locking**
fully integrated

 **Construction depth**
90/93 mm

FACT|BOX

- For highly modern architecture: indistinguishable from fixed glazing
- Slim frames for even greater light penetration
- Only available from Internorm: unrivalled, fully integrated I-tec Secure locking mechanism up to resistance class RC 3

Internorm

A perfect blend of design and technology



1 Thanks to **its frame design, the window sash isn't visible from the outside** and is indistinguishable from fixed glazing. In contrast to fixed glazing, the window can be opened, making this design perfectly suited to modern architecture. This window has won multiple awards for this unique feature.

2 The **revolutionary I-tec Secure locking mechanism** makes it virtually impossible to lever the window – a unique feature in the industry. Upon locking, integrated flaps push onto the frame's interior on all four sides, thereby ensuring maximum burglary protection up to resistance class RC 3.

studio

If you're looking for clean lines and a modern design, the KF 520 is available in the **flush-mounted design style studio**. For the exterior, you can choose between aluminium cladding or uPVC.



TIP

I-tec Secure flaps also come with clear advantages for window cleaning, as only a small number of parts protrude from the sash, and frame parts are nearly non-existent.



KF 510

uPVC & uPVC-aluminium windows



I-tec Secure

I-tec Glazing

I-tec Insulation

 **Thermal insulation**
U_w as low as = 0,63 W/(m²K)

 **Noise reduction**
up to 48 dB

 **Security**
up to RC 3

 **Locking**
fully integrated

 **Construction depth**
90/93 mm

FACT|BOX

- Slim, modern frame with square design
- I-tec Secure locking system as standard up to RC 3
- Easy to clean thanks to locking flaps that are integrated into the sash

Internorm

Maximum security and ideal for mix and match



The high proportion of glass – made possible by the slim frame of this window – lets even more daylight into your living area. Maximum security, a simple design and a **perfect match for the HF 510 timber-aluminium window** – the KF 510 is simply a great window.

When combined, 1 I-tec Secure and 2 I-tec Glazing offer maximum burglary protection. The fully integrated I-tec Secure locking system makes it particularly easy to clean.

3 I-tec Insulation: The insulation granules are evenly filled throughout the hollow chambers, which improves thermal insulation and reduces energy costs.

A perfect match

The KF 510 can be perfectly combined with the HF 510 timber-aluminium window (page 56). The external weather-resistant aluminium cladding is the same for both styles, creating a uniform appearance on the outside, whilst offering the choice of uPVC or timber options on the inside. You can tailor the windows to suit your individual requirements and create a harmonious interior design.



home pure

The KF 510 window is exclusively available in the home pure design style and offers modern features. For the exterior, you can choose between an aluminium cladding or uPVC.



KF 410

uPVC & uPVC-aluminium windows



I-tec Glazing

I-tec Insulation

I-tec Decor

Thermal insulation
U_w as low as = 0,62 W/(m²K)

Noise reduction
up to 47 dB

Security
up to RC 2

Locking
Concealed

Construction depth
90/93 mm

FACT|BOX

- With four different design styles, we have a suitable option for every architectural style
- I-tec Decor technology offers customisation of the surface inside
- Optimal thermal insulation with I-tec Insulation

Internorm

Versatile – suitable for all architectural styles



TIP

The KF 410 window is available in all Internorm design styles: flush, square, rounded or contoured – whatever your personal preference. On the outside, you can choose between aluminium cladding or standard uPVC (KF 410 in studio design style is only available with external aluminium cladding).

Whether flush, square, round or contoured – the KF 410 is our most versatile window, available in all four design styles and incorporating Internorm's unique I-tec technology. I-tec Insulation offers significant improvement in thermal insulation by completely filling the frame cavity.

1 I-tec Glazing offers even more protection: The glass pane's all-round bonding with the window provides outstanding stability and burglary protection.

2 I-tec Insulation: The insulation granules are evenly filled throughout the hollow chambers, which improves thermal insulation and reduces energy costs. A benefit for the environment and your budget.

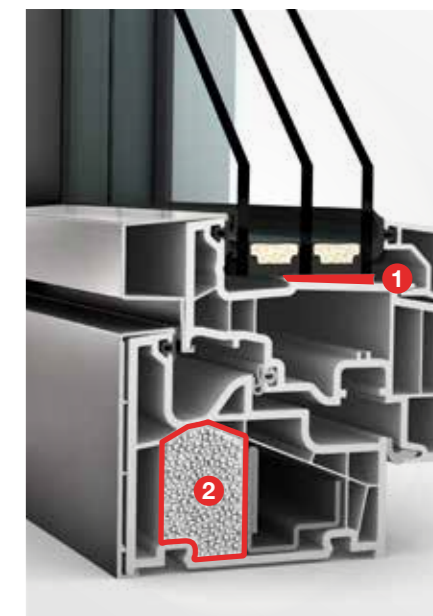

studio



flush

home pure



square

home soft



rounded

ambiente







contoured

KF 320

uPVC & uPVC-aluminium windows



I-tec Glazing

-  **Thermal insulation**
U_w as low as = 0,65 W/(m²K)
-  **Noise reduction**
up to 45 dB
-  **Security**
up to RC 2
-  **Locking**
Concealed
-  **Construction depth**
71/74 mm

FACT|BOX

- A modern window with slim sightlines
- From the outside, the glass sash looks like fixed glazing
- All-round bonding with I-tec Glazing and good security as standard

Internorm

Slim and stylish for modern architecture



TIP

By rendering the window frame on three sides, you can create a **virtually frameless window solution**.

The innovative glass sash gives the KF 320 the appearance of fixed glazing, but is actually a window that can be opened. The glass sash has no visible uPVC sash frame on the outside. Whether you opt for classic uPVC in white, or add aluminium cladding externally, this slim, flush window frame defines the minimalist studio design style.

- 1 The 6-chamber frame profile provides improved thermal insulation.** Triple circumferential gaskets protect the interior from moisture and at the same time improve thermal insulation and noise reduction.
- 2 I-tec Glazing**, the all-round bonding of glass to frame, provides outstanding stability and security.

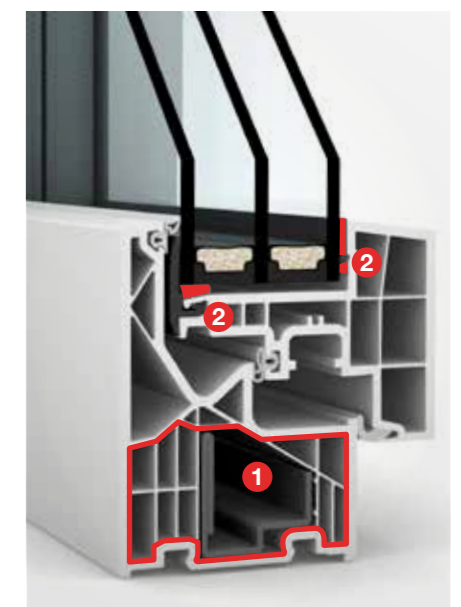

studio

Available in the modern, flush studio design style







KF 310

uPVC & uPVC-aluminium windows



I-tec Glazing

I-tec Decor

-  **Thermal insulation**
U_w as low as = 0,69 W/(m²K)
-  **Noise reduction**
up to 45 dB
-  **Security**
up to RC 2
-  **Locking**
Concealed
-  **Construction depth**
71/74 mm

FACT|BOX

- Low construction depth and slim sightline
- Excellent thermal insulation and noise reduction values
- All-round bonding and good security as standard
- I-tec Décor – for individual design options

Internorm

Proven quality with excellent performance



Developed by our experienced in-house product development team, the KF 310 features tried and tested technologies – outstanding thermal and sound insulation, combined with I-tec Glazing, the all-round bonding of the glass pane to the window sash.

The KF 310 is available as uPVC or uPVC-aluminium window **in three design styles**.

① A slim window, with a **construction depth of 71 mm** (74 mm with aluminium cladding).

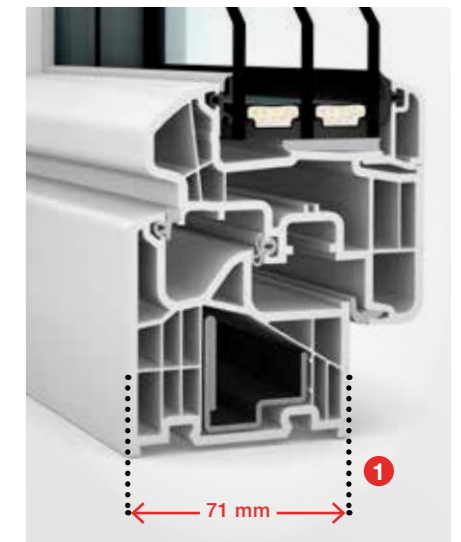

home pure

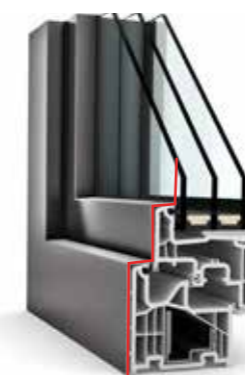

square-edged

home soft



rounded

ambiente



contoured

Available in three design styles to match your building style



Our timber- aluminium window for natural comfort in your home

With our range of design styles, you can tailor your new timber-aluminium windows to suit your home. Further personalisation can be achieved: hundreds of colours available for the external aluminium cladding, a range of beautiful internal timber options, as well as a choice of window handles.

What our timber-aluminium windows have to offer

The innovative timber-aluminium composite windows from Internorm

Particularly slim and modern due to a slim sightline – maximum glass for increased light transmission and improved living comfort.



I-tec Glazing

The glass pane's all-round bonding with the window frame provides **exceptional stability** and **burglary protection**. This technology is integrated into all our timber-aluminium systems as standard.



Independent of timber type, the unique **timber-thermal foam-aluminium** bonding offers outstanding thermal insulation with a low construction depth.



The **many different colours and types of timber** offer you countless options to personalise the colour schemes of your interior spaces, beautifully coordinating the windows with your interior design.



The perfect combination: Mix and match timber-aluminium windows with our uPVC-aluminium windows. The external weather-resistant aluminium cladding is the same for both styles, creating a uniform appearance on the outside, whilst offering the choice of timber options or uPVC on the inside. So you can opt for uPVC-aluminium for your bathrooms and timber-aluminium for all other rooms.



The durable and low maintenance external aluminium cladding is available in a wide choice of RAL colours. Also choose from textured or wood effect finishes. For aluminium colour options see page 106.



Please note that not all options are available for all window systems. HF 510 is pictured here.

Internorm





HF 520

Timber-aluminium windows



GERMAN
DESIGN
AWARD
WINNER
2025

I-tec Glazing

-  **Thermal insulation**
U_w as low as = 0,71 W/(m²K)
-  **Noise reduction**
up to 47 dB
-  **Security**
up to RC 2
-  **Locking**
Concealed
-  **Construction depth**
90 mm

FACT|BOX

- Unique modern and flush design with the appearance of fixed glazing
- Particularly slim frame
- Can easily be combined with KF 520
- Concealed hardware

Internorm

Unique
modern and
flush design



The slim frame allows for an abundance of natural light to fill your home. Not only will this have a positive effect on your general wellbeing, it will also minimise the use of lighting, therefore reducing energy consumption. But that's not all: Our products offer maximum sound insulation, optimal thermal efficiency, and highest security standards – that is our promise.

Timber, revered for its timeless beauty and eco-friendly attributes, takes center stage in the HF 520.

A perfect match

Experience the perfect balance between individuality and aesthetics: The new timber-aluminium window HF 520 offers the perfect match to the uPVC-aluminium window KF 520 (Page 40).

You therefore have the choice of material on the inside, with the same aluminium cladding on the outside, creating a uniform and harmonious appearance externally.



studio

With the innovative glass sash of the HF 520, the frame is not visible from the outside, giving the appearance of fixed glazing.







HF 510

Timber-aluminium windows



I-tec Glazing

-  **Thermal insulation**
U_w as low as = 0,65 W/(m²K)
-  **Noise reduction**
up to 47 dB
-  **Security**
up to RC 2
-  **Locking**
Concealed
-  **Construction depth**
85 mm

FACT|BOX

- The slimmest of our timber-aluminium windows for even more daylight
- Minimalist and modern design coupled with the natural look of timber
- Maximum design freedom and ideal combination options



Internorm

Combining modern design with a natural finish

This window meets the **most demanding requirements in design** – slim, modern and elegant. It can easily be combined with our KF 510 uPVC-aluminium window in one project – the external aluminium cladding will match perfectly, creating a seamless, uniform look.

The slim sightlines of the HF 510 timber-aluminium window provide a modern solution – maximum glass for increased light transmission and improved living comfort. Why not match this window with the HS 330 lift & slide door, available with the same timber options?

Mix and match

The advantage of the Internorm window systems is that whatever material you choose on the inside – natural timber or contemporary uPVC – the outside will always look the same. Combining the HF 510 timber-aluminium with the KF 510 uPVC-aluminium window (page 42) means that you can coordinate your internal materials with your individual room requirements without losing the harmonious appearance on the outside.



home pure

The modern, square design perfectly aligns with the requirements of contemporary architecture. With the internal choice of timber finishes, combined with the external, hard-wearing aluminium cladding, the HF 510 offers a wide range of design options to suit your project.







HF 410

Timber-aluminium windows



I-tec Glazing

-  **Thermal insulation**
U_w as low as = 0,64 W/(m²K)
-  **Noise reduction**
up to 46 dB
-  **Security**
up to RC 2
-  **Locking**
Concealed
-  **Construction depth**
85 mm

FACT|BOX

- Suitable for all architectural styles
- Many types of timber, surfaces and colours to choose from
- Can be optimally adapted to suit your interior design



**Natural
all-rounder for
any building
requirements**

Internorm



Windows and large areas of glazing have become an essential feature of modern architecture. The selection of colours and materials for floors and furniture plays a crucial role in creating a harmonious overall feel – so you can design your individual living environment. The wide range of colour and timber options for the HF 410 offers countless possibilities to fashion your living space in a unique way – no matter the building style. You can also easily combine this window with our HX 300 fixed glazing.

1 The **timber-thermal-foam-aluminium bonding** offers outstanding thermal insulation at a low construction depth, resulting in energy cost savings.

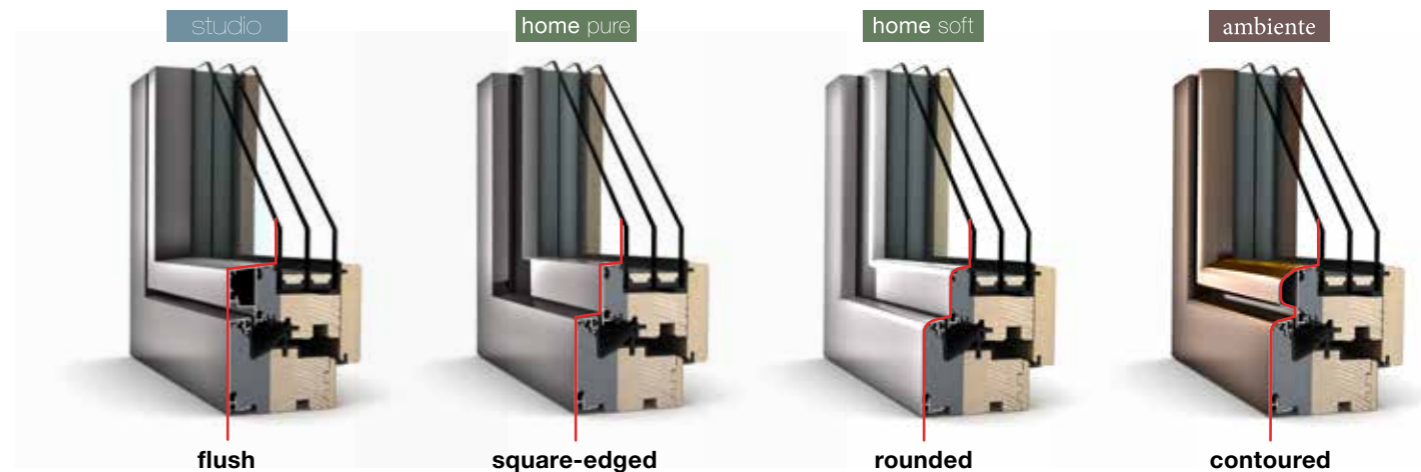

The HF 410 is available in all four design styles, making it ideal for any architectural style.

Passivhaus Selfbuild

A calm oasis with spectacular coastal views



Internorm

“Living on the coast in the West of Ireland, we needed windows and doors that would withstand the elements, and the high quality of Internorm provided just that”.



Stunning Selfbuild in the West of Ireland to Passivhaus Standard

When arriving at the location of this stylish selfbuild, you are immediately drawn to the views. The building is situated in an enviable position that made the design process an absolute joy.

The homeowners were moving back to Ireland after ten years living abroad. They had a very clear vision of what they wanted to achieve. Working closely with the architect, a Passivhaus designer, they wanted to create a modern, highly energy-efficient and sustainable family home for themselves and their three children. Warranties and performance were important. The choice of Internorm's internal timber options and unlimited colours for the external aluminium cladding beautifully complemented the materials and colour palette of their stylish, natural interior design choices. The build was not straightforward. There are complexities within the build that enabled them to have such features as the frameless glass-to-glass corner window, and the sheer amount of glazing to the rear of the house. "My advice would be to understand, that embarking on a selfbuild is not a sprint, it's a marathon. It's unpredictable and it's all encompassing. Prepare yourself for that and take great satisfaction and pride in each milestone, knowing that you are part of what is being created. It is an incredible achievement to do a selfbuild, and we are proud of what we achieved with the support of everyone".



“The corner window is our favourite spot! Everyone is drawn to stand or sit there and enjoy the unobstructed views.”

Watch their full Case Study Video





Perfect for a renovation – our windows with integrated blinds

Internorm windows with accessible integrated blinds are unique within the fenestration industry. The blind, housed between window panes, is protected from wind, rain and dirt.

What our windows with integrated blinds have to offer.

Outstanding protection in one window.

I-tec Shading

Sun protection



I-tec Shading creates the perfect room temperature. With its photovoltaic module and back-up battery, it is completely self-contained, without the need for an additional energy supply. When set to automatic mode, the Venetian blinds open and close automatically at sunrise or sunset. This is controlled by built-in sensors, which means that you can make the most of the sunlight in winter, with the Venetian blinds fully open.

A choice of uPVC and timber is available for the inside.



TIP



Screen

Internorm offers integrated blinds with both uPVC-aluminium and timber-aluminium composite systems. You can choose from three blind options – Venetian, Roman or Duette black-out blinds. So whatever blind you choose, it will be completely protected from the elements due to its location within the sealed glass panes.



Duette®



Roman blind



TIP

For renovators: Windows with integrated blinds are ideal for renovation projects, as there is no need for separate sun protection. They are also a great solution for facades where shutters are not permitted.

Easy operation



Easily control your Venetian blinds on the window.

I-tec Insulation

I-tec Glazing

Thermal insulation and noise reduction

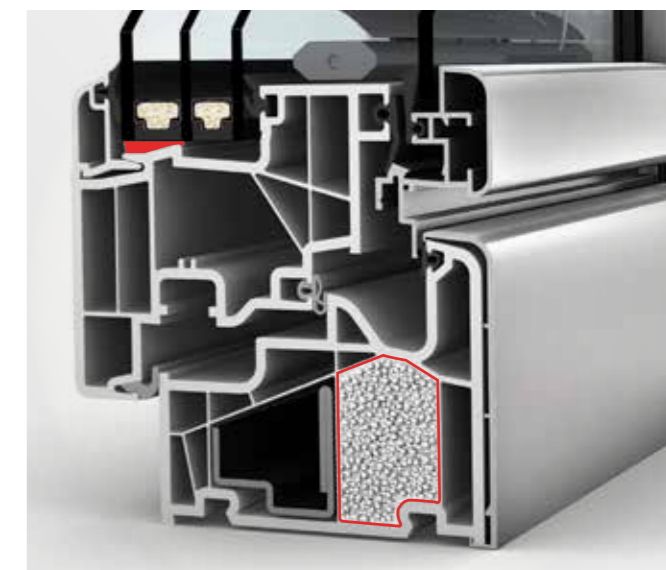

The insulation granules evenly fill the hollow chambers, which improves thermal insulation and reduces energy costs. In addition, the windows with integrated blinds offer improved noise reduction, so noise from the outside stays outside.

Please note that not all integrated blind options are available with all window systems.

KV 440

uPVC-aluminium windows with integrated blinds



Self-sufficient: The I-tec Shading option is powered by sunlight via a photovoltaic module, therefore not requiring an external power source.



KV 440, the uPVC-aluminium window with integrated blinds, has a construction depth of 93 mm and can easily be **combined with the uPVC-aluminium window KF 410.**

home pure home soft ambiente

Select the design style to suit the design of your house.

Thermal insulation
U_w as low as = 0,64 W/(m²K)

Noise reduction
up to 45 dB

up to
bis RC 2

Locking
Concealed

Construction depth
93 mm

I-tec Connect I-tec Insulation

I-tec Glazing I-tec Shading

KV 350

uPVC-aluminium windows with integrated blinds

Internorm



1 The **6-chamber frame profile provides improved thermal insulation.** Triple gaskets protect the interior from moisture, whilst at the same time improving thermal insulation and noise reduction.



With a construction depth of 74 mm, **this window is ultra-slim.** You can also perfectly **combine it with the KF 310 uPVC-aluminium window.**

home pure ambiente

For this window you can choose between the **home pure** and **ambiente** design styles.

Thermal insulation
U_w as low as = 0,79 W/(m²K)

Noise reduction
up to 44 dB

Security
up to RC 2

Locking
Concealed

Construction depth
74 mm

I-tec Connect I-tec Shading

I-tec Glazing



HV 450

Timber-aluminium windows with integrated blinds



I-tec Connect

I-tec Glazing

I-tec Shading

 Thermal insulation
U_w as low as = 0,62 W/(m²K)

 Noise reduction
up to 46 dB

 Security
up to RC 2

 Locking
Concealed

 Construction depth
85 mm

FACT|BOX

- Blinds sit between the window panes
- Sun and privacy protection, as well as thermal insulation and noise reduction in just one window
- Many types of timber, finishes and colours to choose from

Internorm

Quadruple protection in just one window

TIP

Our windows with integrated blinds can **easily be combined with our other windows.**

With **perfect sun and privacy protection, as well as thermal and noise reduction**, you can enjoy quadruple protection in just one window. I-tec Shading works entirely without an external power source and also offers many useful features such as temperature sensors and day/night recognition. **The blind offers sun protection and privacy**, and is integrated between the panes. This not only comes with advantages for cleaning, but also protects the material from the elements.



home pure home soft ambiente

To match your building style, the HV 450 offers a suitable option in **home pure, home soft** and **ambiente**.





Lift & slide doors and fixed glazing – for limitless freedom

Modern architectural glazing creates a new style of living. Large glass surfaces extend the living space beyond its actual limits. Internorm offers lift & slide doors and large fixed glazing to create this feeling of freedom.

KS 430

uPVC & uPVC-aluminium lift & slide door



FACT|BOX

- Slim sightlines and virtually frameless fixed panels, which can be fully rendered
- Inside can be customised with I-tec Decor technology
- Soft close handle for smooth handle return included as standard
- Maximum thermal insulation

More light with large elements
up to 6500 x 2800 mm, and a sash of up to 400 kg

Standard ESG-glass panes
protect from injuries.

The standard threshold can be installed at the same level as your flooring, offering comfortable, barrier-free passage.

I-tec Decor

- Thermal insulation**
 U_w as low as = 0,64 W/(m²K)
- Noise reduction**
up to 43 dB
- Security**
up to RC 2



Comfort Drive – allows your lift & slide door to be opened via electric operation.



The KS 430 is **available as a uPVC or uPVC-aluminium option** – can be perfectly combined with your windows.

HS 330

Timber-aluminium lift & slide door

Internorm



FACT|BOX

- Highly energy-efficient: Fibreglass threshold for optimum thermal insulation
- Virtually frameless glazing achieved with fully rendered fixed elements
- Easy to lift and slide up to 400 kg sash weight

In combination with fixed glazing for even bigger glass surfaces; frameless glazing through fully rendered fixed element

Stylish colour options for personal design choices – can be perfectly combined with the timber-aluminium windows HF 410, HF 510 and HV 450.

Sizes of up to **580 x 280** cm can be manufactured as standard – and even larger following technical clarification.

- Thermal insulation**
 U_w as low as = 0,73 W/(m²K)
- Noise reduction**
up to 40 dB
- Security**
up to RC 2



Comfort Drive – allows your lift & slide door to be opened via electric operation.



I-tec Glazing

The glass pane is bonded on all four sides to the frame, providing **outstanding stability** and **burglary protection**.



FACT|BOX

- Open and bright: glass joints are nearly invisible
- Large-scale glazing possible
- Frame disappears almost entirely into the facade

HX 300

Timber-aluminium
fixed glazing

Internorm

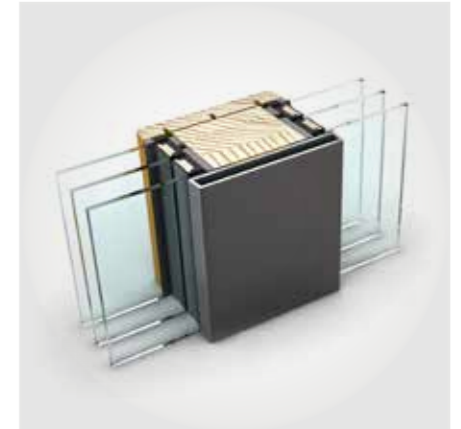

You can create **visual features** with integrated windows.

The **strong frame construction, glued with multiple layers**, enables a glass surface of up to 10.5 m².





HX 300 offers the **optimal construction connection** for floor to ceiling glass surfaces.



The slim glass joint allows for large expanses of glass.

This large-scale timber-aluminium glazing can be fully integrated into the brickwork, creating a stunning frameless design feature for your home. Innovative glass joints create a near invisible transition between glass panes, therefore providing many options for modern, large-scale architectural glazing. HX 300 panoramic glazing is available with glass surfaces of up to 10.5 m², making the frame disappear almost entirely into the facade.

 **Thermal insulation**
U_w as low as = 0,74 W/(m²K)

 **Noise reduction**
up to 47 dB

Internorm – as varied as your dream home

Windows, large-scale glazing such as lift & slide doors and entrance doors – at Internorm, you get everything from a single source – **100% made in Austria** and with reliable quality.



Timber-aluminium

Beautiful natural timber offers warmth, provides a pleasant atmosphere, and is ideal for living rooms and bedrooms.



uPVC-aluminium

uPVC is durable, exceptionally low-maintenance and thereby perfectly suitable for rooms with high humidity, e.g. bathrooms.



It is easy to combine our timber-aluminium windows with our uPVC-aluminium windows. The aluminium cladding can be designed to match, thereby creating a uniform look for the exterior.

If you need a uPVC-aluminium window for your bathroom or wetrooms to match the timber-aluminium windows in your living room, no problem. There are many combinations for you to select. From the hundreds of colours for the external aluminium cladding, to timber options and uPVC Decor colours internally, as well as a range of window handles – the choice is yours. Create your dream home the way you envision it.



Lift & slide doors

Our lift & slide doors, combined with fixed glazing, offer the ultimate sense of space, flooding your home with natural daylight and creating a seamless transition for indoor/outdoor living.

Sun protection and flyscreens

To avoid overheating, it is important to include shading. Our range of sun protection, and fly screens, provides a comfortable living space.



Entrance doors

Expect the same high standard from your Internorm entrance door. Available in aluminium and timber-aluminium, you can choose from flush, ultra-modern to traditional, and create a secure entrance that reflects your taste.





Our entrance doors

Every Internorm entrance door is unique, individual and timeless.

Whether you choose one of our aluminum or timber-aluminium door systems, there is a wide range for stunning designs and accessories to suit your requirements and taste.

The entrance door – as unique as you

Each bespoke Internorm entrance door is manufactured to your individual requirements. The result is a unique door that is perfectly suited to you and your home.

To help you choose your perfect entrance door, you will find a selection of models and options on the following pages. With a wide range of colours, finishes, handle and glass options, you can give your door a personal touch. Create an impressive entrance that not only matches the style of your house, but also reflects your personality.

Why not take advantage of our online **Door Designer** tool for even more options? Design and customise your entrance door exactly how you want it. Or let our Internorm **1st window partners** advise you.

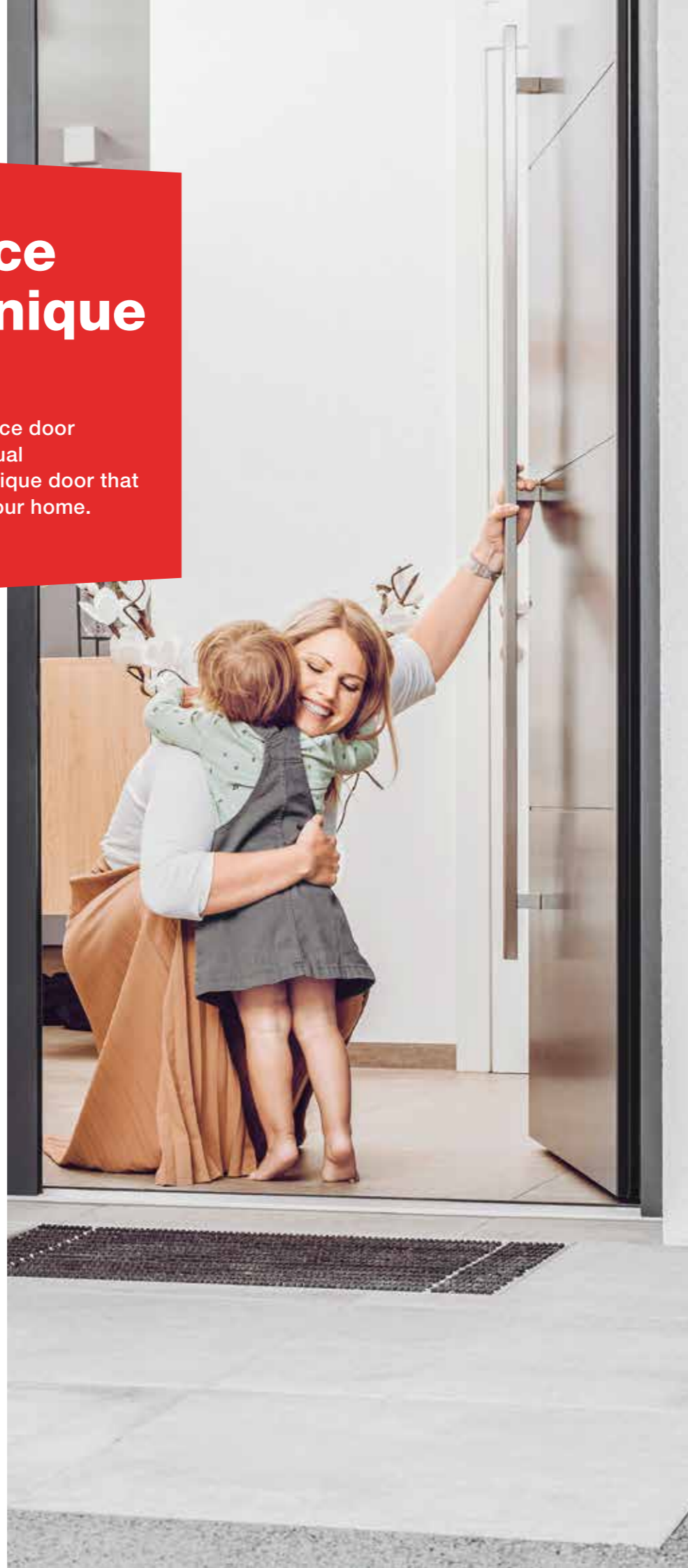

For the inside, choose from many different colours and finishes (page 106/107), as well as interior design options (page 113).

A wide range of colours, designs and materials is available for the outside (page 106).

Smart access control systems are available on request (e.g. fingerprint scanners, page 122/123)

Every door is also available with the option of side lights and/or fanlights.

Structural, design and motif glass (page 114/115)

Handle options at a glance (pages 110 – 112)

Model details

Designation

FA

Colour:
Handle:
Glass:
Order No.:

Order number of the depicted door model



The QR code provides valuable information on available options for every door series.

MODELL / TYPE FA	A	B	K	H
AT 500	X			
AT 510	X			
AT 520	X	X	X	X
AT 525	X	X	X	X
AT 530	X	X	X	X
AT 540	X	X	X	X
HT 400	X	X		X
HT 410	X	X		X

What our entrance doors have to offer

An entrance door is the stand-out feature of your house, which is why Internorm only offers unique, premium doors, that are tailor-made for you to the highest standards. Choose from seven distinct series to create your exclusive door.



Timber-aluminium entrance doors

Many customers still want the warm, natural feel of timber on the inside. However, timber is more susceptible to weathering. With an external aluminium panel, the door is protected from harmful weather conditions. Timber also offers very good insulating properties, which is why timber-aluminium entrance doors are perfectly suited to low-energy homes.

TIP

Our timber-aluminium entrance doors are a perfect **fit for low-energy and passive houses.**

HT 410

Flush on the inside and outside



HT 400

Square-edged on the inside and outside

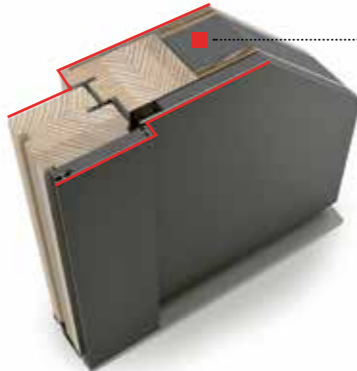

Thermal foam insulation

The material compound of timber, aluminium and thermal foam provides **optimal thermal insulation and energy efficiency.**

Thermal insulation
U_D as low as = 0,55–0,67 W/(m²K)

Noise reduction
up to 34 dB

Security
up to RC 2

Mehrfachverriegelung

Construction depth
85–121 mm

Internorm

Design options

The respective systems with their **various abbreviations (AT 540, AT 530, HT 410, etc.)** feature different functionalities and features. Each system offers different functionalities, features and design, from flush or square, to contoured.



Aluminium entrance doors

Aluminium entrance doors are light, but also exceptionally strong and weather-resistant. Incorporating a 3-chamber frame profile, foam insulation core (or insulating glass core for AT 510), and a thermally broken threshold, it offers optimal thermal insulation.

AT 540

Flush on the inside and outside



AT 530

Square-edged on the inside and outside

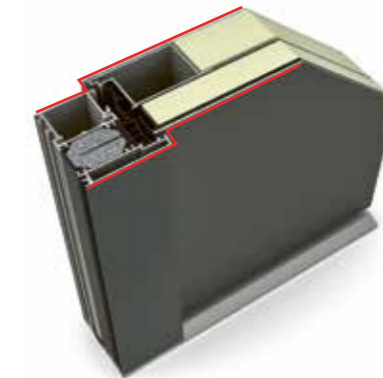

AT 525

Square-edged on inside, flush on the outside



AT 520

Contoured on the inside, square-edged on the outside

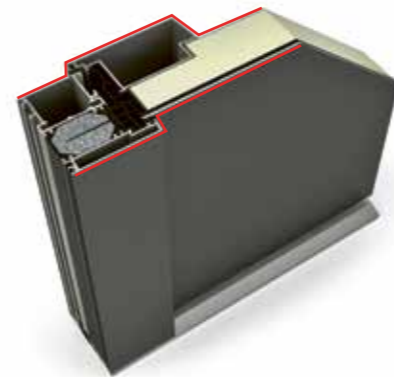

AT 510

Contoured on the inside, square-edged on the outside



AT 500

Contoured on the inside and outside

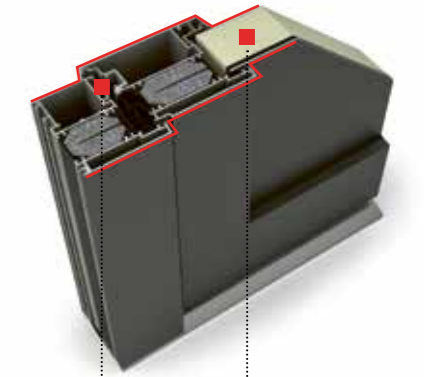

Thermal insulation
U_D as low as = 0,69–0,95 W/(m²K)

Noise reduction
32 to 40 dB

Security
RC 2 to RC 3

Locking
Multiple

Construction depth
93 mm

Optimal thermal insulation

All our aluminium entrance doors feature a **3-chamber frame profile and a foam insulation core** for outstanding thermal insulation (except AT 510 – insulating glass core). The triple gaskets guarantee protection from moisture and cold.

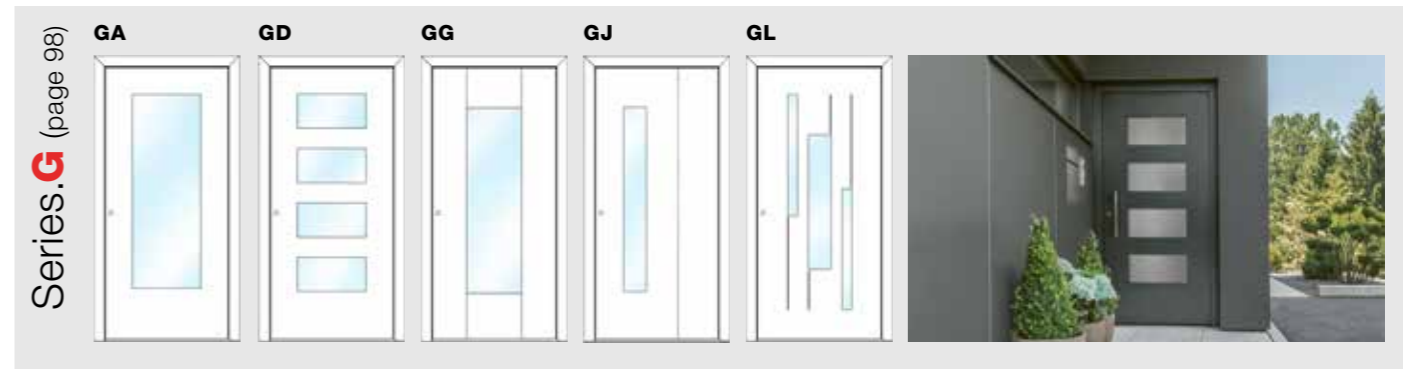
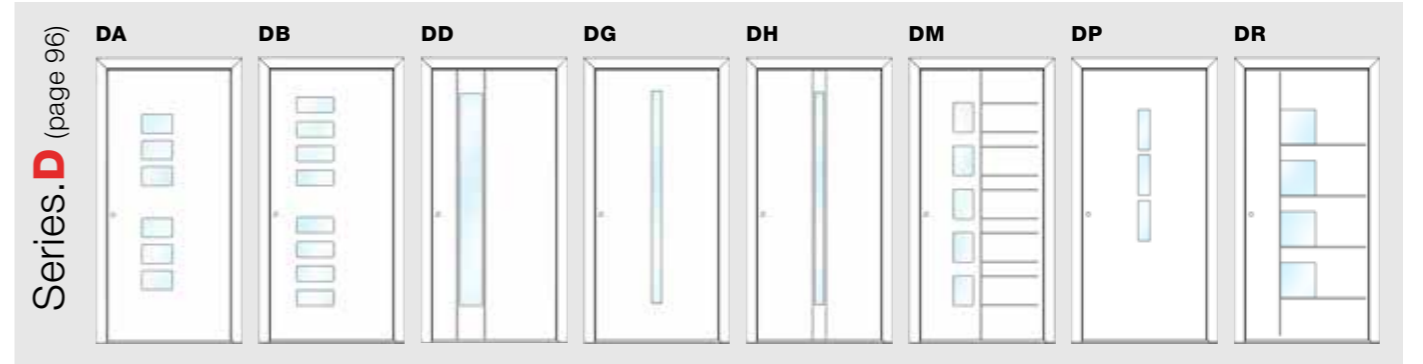
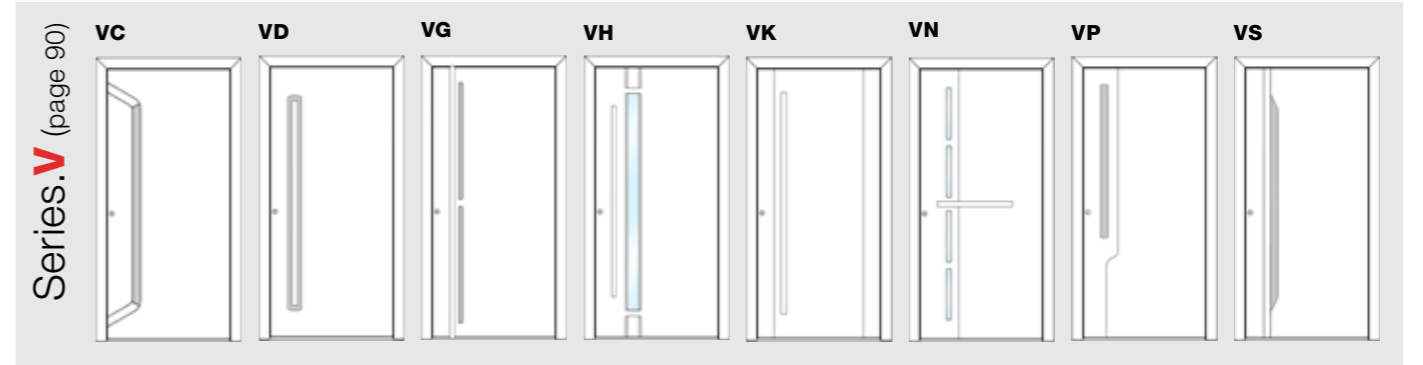

Solid designer panels

Doors with solid panels look stunning and keep your home private. Create your contemporary entrance door with discreet groove milling and aluminium strips. A choice of straight or recessed handles will add to the overall design to create an impressive and modern entrance area.

FA
 Colour: HM721
 Handle: KGS01A
 Sidelights: Clear glass
 Order No.: F0202

TIP

Scan the QR code and find out which door models can be combined with which surfaces and systems.



FD
 Colour: Frame HM716, sash SD10 Antique wood, HM716
 Handle: RGS05
 Order No.: F0002



FR
 Colour: Frame RAL 9005, sash SD08 Art-Basalt
 Handle: GKV03
 Designer panels: Aluminium trims
 Base profile: Stainless steel 20 mm
 Order No.: F0201



FT
 Colour: Frame RAL 9005, sash SD09 Art-Carrara
 Handle: SG17 black
 Designer panels: Aluminium trims
 Base profile: black 20 mm
 Order No.: F0054



FU
 Colour: HFM14
 Handle: SG13
 Order No.: F0200



FJ
 Colour: Frame RAL 9005, sash SD05 Art-Corten
 Handle: KGS04
 Designer panels: Aluminium trims
 Base profile: Stainless steel 20 mm
 Order No.: F0052



FO
 Colour: HM722
 Handle: RGS01
 Base profile: Alunox 20 mm
 Order No.: F0050

Design YOUR individual door

We will show you how versatile our entrance doors are by using two popular models in the flush AT 540 design as examples.



Design further options with our online door designer!



Model.**FG**



Satinato white with house number in clear glass



Raised alu strips

Colour: Frame HM819, sash SD05 Art-Corten, Handle: KGS05, Designer panels: : Raised alu strips, Glass: Motif glass MNSE, Base profile: Stainless steel 20 mm, Order No.: F0203

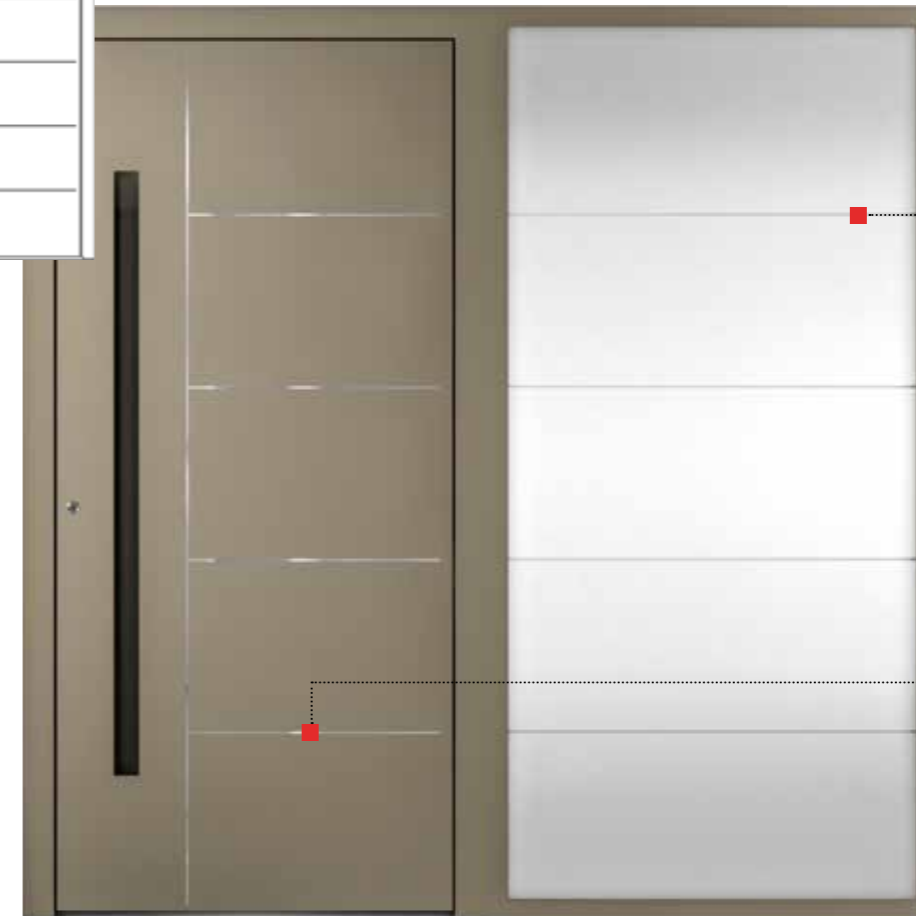

Model.**FP**



Sandblasted surface area with clear stripes

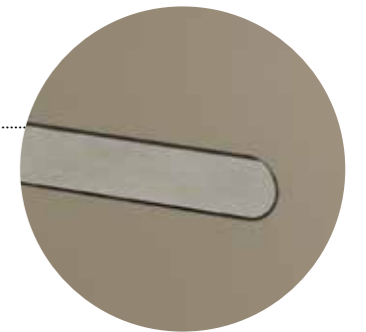

flush black alu strips

Colour: HM739, Handle: GSI03, Designer panels: Flush alu strips, Glas: Motivglas MF42SE, Order No.: F0204



Colour: Frame EL02, sash HFM03, Handle: RGS05, groove milling



Colour: Frame HM716, sash HFM11, Handle: GKV03 black, flush black alu strips



Colour: HDS02, Handle: HGS03, Raised alu strips



Colour: HFM14, Handle: EGS01, groove milling



Colour: Frame HM735, sash HM735, RAL 5009, Handle: KGS05, groove milling



Colour: Frame HFM12, sash HFM11, HFM12, Handle: HGS04 black, flush black alu strips



Colour: Frame HM704, sash HM704, M916, Handle: KGS03, groove milling



Colour: HM817, Handle: SG18, Flush alu strips

Modern meets visionary

Stunning new designs and exceptional quality live up to even the most demanding ideals of modern living. Our new designer doors combine elegance and individuality and will win you over with stylish details.



VN

Colour: Frame HM712, sash HM712, RAL 9005
Handle: GPR60
Glass: Satinato white
Sidelights: Clear glass
Order No.: V0002

TIP

Scan the QR code and find out which door models can be combined with which surfaces and systems.



reddot winner 2023 Prestigious award for the VD, VN, VG, VP and VK models



VG

Colour: Frame RAL 9005, sash SD10 Antique wood
Handle: GKVV black
Order No.: V0003



VC

Colour: HM906
Handle: GSIV black
Designer panels: black fine structure
Order No.: V0100



VD

Colour: RAL 9005
Handle: GSHG black
Order No.: V0001



VS

Colour: HM712
Handle: GSIV black
Designer panels: black fine structure
Order No.: V0101



VP

Colour: Frame RAL 9005, sash SD03 Art-Beton, RAL 9005
Handle: GSIV black
Order No.: V0004



VK

Colour: Frame HM819, sash HM819, RAL 9005
Handle: GPRV black
Order No.: V0005

Symmetry in balance

This extensive range of doors impresses with its simplicity and symmetry. Whether you opt for a full-length slim glass window or prefer perfectly aligned smaller windows in the centre or the side, the choice is yours.

To create an even more individual entrance door, you can add milled grooves or decorative aluminium trims.



PG

Colour: Frame RAL9005, sash SD08 Art-Basalt
Handle: GKV03 black
Special Glass: Dark Grey
Base profile: black 20 mm
Order No.: P0201

TIP

Scan the QR code and find out which door models can be combined with which surfaces and systems.

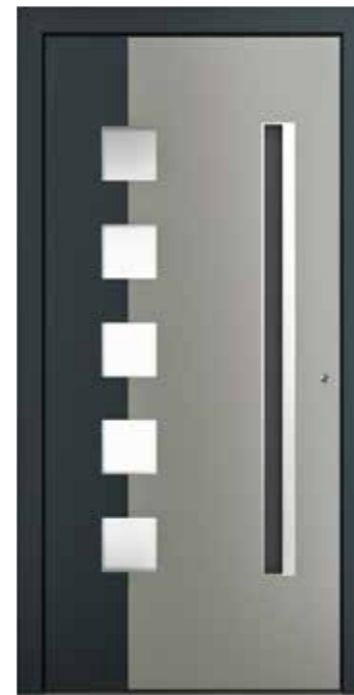

PQ

Colour: Frame HM721, sash HM721, HM907
Handle: SG18
Glass: Satinato white
Order No.: P0010



PA

Colour: Frame RAL 9005, sash SD10 Antique wood
Handle: HGS01 black
Glass: Satinato white
Order No.: P0001



PR

Colour: HFM12
Handle: GPR60
Glass: Satinato white, Alunox glass surround
Order No.: P0200



PS

Colour: HM817
Handle: GSI03 black
Motivglas: MP43FE
Order No.: P0012



PK

Colour: M916
Handle: RGS03
Glass: Satinato white
Order No.: P0006



PE

Colour: HM716
Handle: EGS01
Glass: Satinato white
Order No.: P0003

Make a door YOUR door!

We will show you how versatile our entrance doors are by using two popular models in the square AT 530 design as examples.



Design further options with our online door designer!

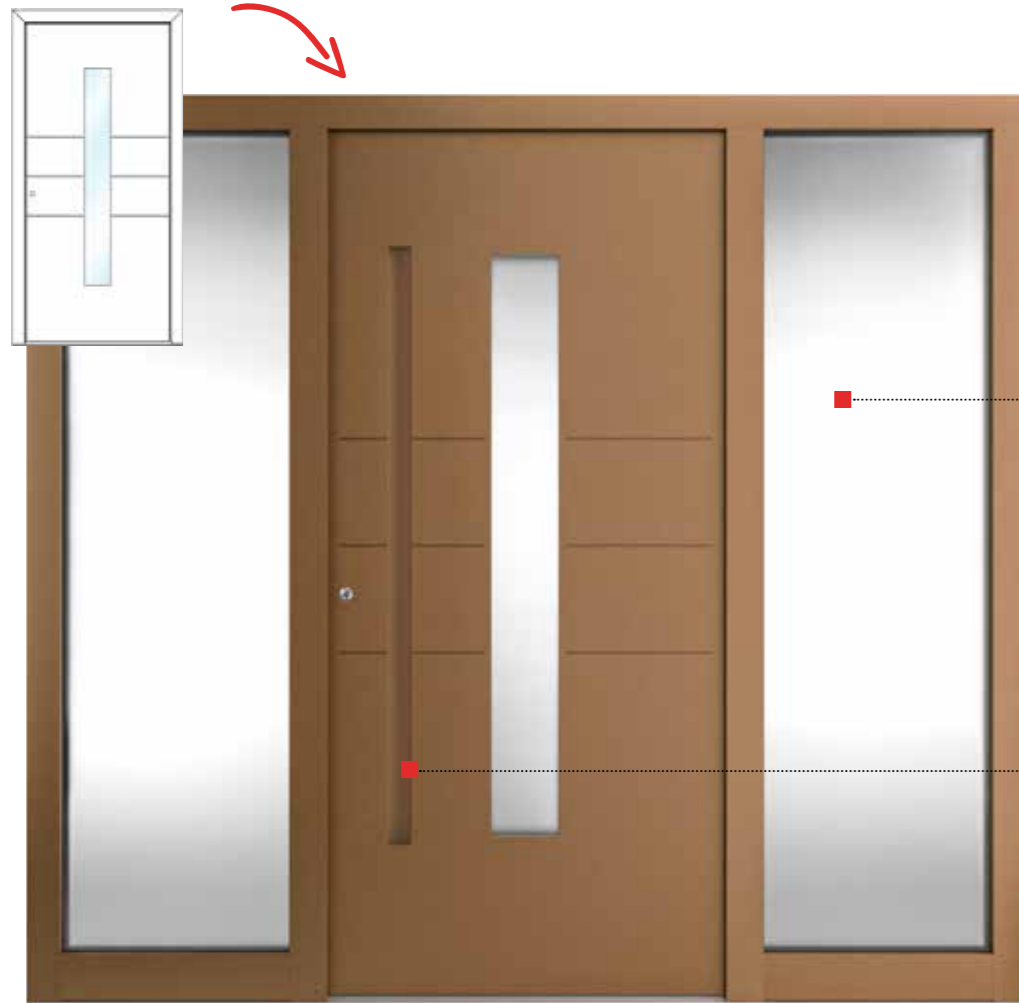

Model.PD



No two houses are the same. This also applies to the entrance area. That is why we offer sidelights in between 333 – 2000 mm in width.



Recessed handle to match colour of door sash or in black

Colour: HFM21, Handle: GSI03, Glass: Satinato white, Order No.: P0050

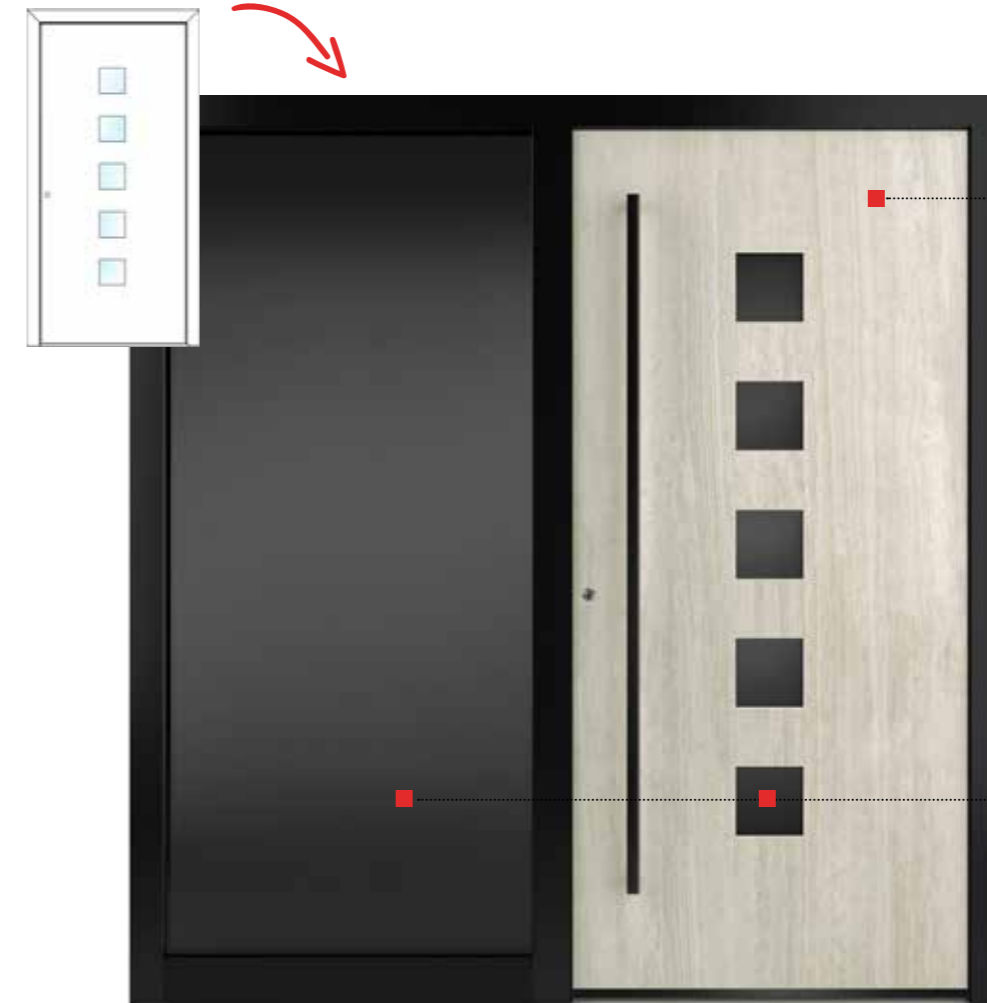

Model.PM



Marble-look ceramic surface



Large selection of different glass options

Colour: Frame RAL 9005, sash SD09 Art-Carrara, Handle: GKV04, Glass: Dark Grey + side panel Dark Grey, Base profile: black 20 mm, Order No.: P0202



Colour: HM113, Handle: HS42, groove milling, Glass: Satinato white



Colour: HF739, Handle: RGS01, Flush alu strips, Glass: Satinato white



Colour: Frame RAL9005, sash HFM11, Handle: KGS04 black, raised black alu strips, Glass: Satinato white



Colour: HDS08, Handle: GKV03 Alunox-Fassung, flush alu strips, Glass: Satinato white



Colour: Frame HM803, sash HDS06 Handle: RGS02, Glass: Satinato white



Colour: Frame EL01, sash M916 Handle: RGS05, Alunox frame Glass: Satinato white



Colour: Frame HM704, sash SD06 Art-Steel, Handle: SG18, Glass: Satinato white Base profile: Stainless steel 20 mm



Colour: Frame RAL 9005, sash HFM14, Handle: HGS04 black Glass: Satinato white Socket: black 80 mm

Discreet and elegant details

This beautifully designed range focuses on discreet, narrow glass windows and rectangular cut-outs, enhancing the overall appearance. Square or long, slim glass features dominate the design. Milled grooves and decorative aluminium trims add further individual touches.

DD

Colour: HM716
 Handle: GOK60
 Designer panels: Aluminium trims
 Glass: Satinato white
 Base profile: Alunox 20 mm
 Order No.: D0003

TIP

Scan the QR code and find out which door models can be combined with which surfaces and systems.



DR

Colour: Frame RAL 9005, sash SD10 Antique wood
 Handle: HGS03 black
 Designer panels: Aluminium trims
 Glass: Satinato white
 Order No.: D0008



DG

Colour: Frame RAL 9005, sash HM704
 Handle: SG17
 Glass: Satinato white, Alunox glass surround
 Base profile: Alunox 20 mm
 Order No.: D0004



DM

Colour: Frame HFM12, sash HFM12, M916
 Handle: HGS04
 Glass: Satinato white
 Order No.: D0006



DH

Colour: Frame RAL 9005, sash SD03 Art-Beton
 Handle: KGS04 black
 Designer panels: Aluminium trims
 Glass: Satinato white
 Order No.: D0005



DB

Colour: Frame HM721, sash SD05 Art-Corten
 Handle: KGS01
 Glass: Satinato white
 Base profile: Stainless steel 20 mm
 Order No.: D0052



DA

Colour: HM712
 Handle: HS40
 Glass: Satinato white
 Order No.: D0200

Focus on glass

With the third series in this range, the emphasis is very clearly on the glass elements. Depending on the model and personal preference, milled grooves and decorative aluminium trims can be added.



TIP

Scan the QR code and find out which door models can be combined with which surfaces and systems.



GD

Colour: HFM05
Handle: KGS04
Glass: Satinato white
Order No.: G0100



GG

Colour: HF113
Handle: RGS05
Glass: Satinato white,
Alunox glass surround
Order No.: G0003



GA

Colour: HM716
Handle: HS42
Glass: Satinato white
Order No.: G0001



GL

Colour: HM704
Handle: KGS04
Glass: Satinato white
Order No.: G0201



GJ

Colour: Frame RAL6003,
sash RAL6003, RAL1032
Handle: SG13
Glass: Satinato white
Socket: Alunox 80 mm
Order No.: G0200

Bespoke, personalised design solutions

Each door from our different series can be customised to suit your individual requirements. However, Internorm entrance doors offer maximum flexibility. You can add different panels, glass, glazing bars or a mix of all these to create exactly what you want. Your Internorm distribution partner will be happy to advise on the options available.

Illuminated recessed handle

The LED recessed handle from Internorm can be integrated flush into the entrance door.



Illuminated door panel

LED lighting is integrated into the threshold area of the door, creating a well-lit entrance.

Mirrored doors

are simple, but clever and practical. The mirror can be framed or bonded to the inside. Whatever you choose, you can check your appearance before you leave the house.



MOTIF GLASS DESIGN

Colour: HM721
Handle: EGS01
Motif glass: MF72FE
Order No.: X0101



MOTIF GLASS DESIGN

Colour: HM704
Handle: EGS01
Motif glass: MS71FE
Order No.: X0100



MOTIF GLASS DESIGN

Colour: HM304
Handle: EGS01
Motif glass: MF22FE
Order No.: X0203



TRANSOM DESIGN

Colour: M916
Handle: HS50
Glass: Satinato white
Sprossen: 97 mm
Order No.: X0201



TRANSOM DESIGN

Colour: HM113
Handle: RSS06
Glass: Satinato white
Order No.: X0200



GEORGIAN BAR DESIGN

Colour: HM817
Handle: HS30
Glass: Satinato white
Sprossen: 60/40 mm
Order No.: X0202





Architekt: Spee architecten / Fotograf: Ossip van Duivenbode

Side and back entrance doors

Security is not just important for windows and entrance doors. Side and back doors have to offer the same protection. And they have to look good of course.

Side entrance doors serve to close off uninhabited, unheated rooms (e.g. garage, basement storage rooms, etc.). Recent statistics show that burglars usually access houses via a side or back entrance. This makes it all the more important to take preventative measures with the right security features. Internorm offers a range of security hardware systems on request.

Side entrance doors are available in aluminium, uPVC, uPVC-aluminium, as well as timber-aluminium with a wide range of options to customise your door.

Internorm

Aluminium



AT 500 Panel design
Colour: HM704
Handle: HS10
Order No.: X0008



AT 500 Glass panel design
Colour: HM716
Handle: HS10
Glass: Satinato white
Order No.: X0010



AT 500 Glass design
Colour: Frame M916
Handle: HS10
Glass: Satinato white
Order No.: X0009



AT 500 Glass panel design
Colour: HM735
Handle: HS10
Glass: Satinato white
Order No.: X0011

uPVC & uPVC-aluminium



KF 510



KF 410



KF 320



KF 310

Timber-aluminium



HF 410 / HF 510



HF 410 / HF 510



Countless design options

Find out more about our extensive range of accessories. Choose from hundreds of colours, handles, glass, sun and insect protection to design your windows, doors and entrance doors for your unique home.

Colours for windows and doors

Colours options of external **aluminium cladding** for windows, as well as internal and **external colours** for entrance doors.

Standard colours*



hiest-Colours***



HDS Colours**

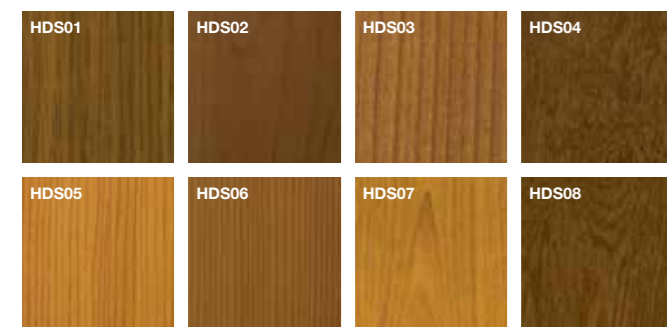

Stainless-steel colours for external window cladding/doors

Stainless-steel colours****

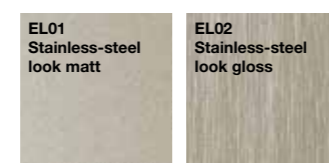

* Highly weather-resistant, except for M916 (facade quality)
 ** Intensive colour, variation possible.
 *** For surface options **HM** (highly weather-resistant standard colour), **HF** (highly weather-resistant fine structure), **HFM** (highly weather-resistant fine structure metallic) a special, highly weather-resistant powder coating is used.
 **** Only possible on both sides of door frame
 ***** Real wood, not suitable for every installation site. Please check with your distribution partner.

Special decor for the exterior of entrance doors

SD colours

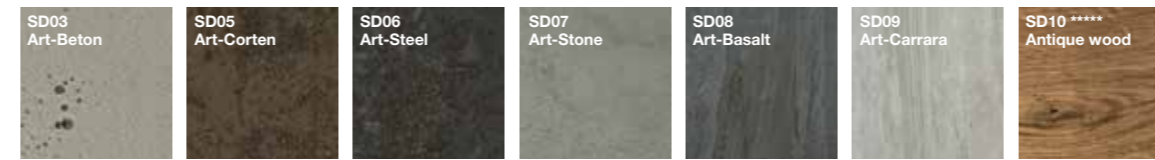

Timber standard colours for the interior of windows and doors

SPRUCE varnished

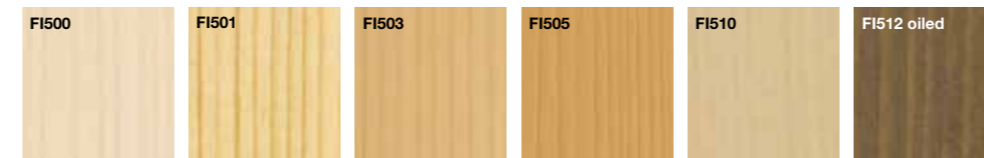

TIMBER opaque

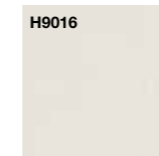

LARCH varnished



WALNUT

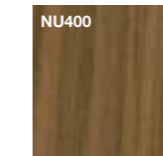

OAK

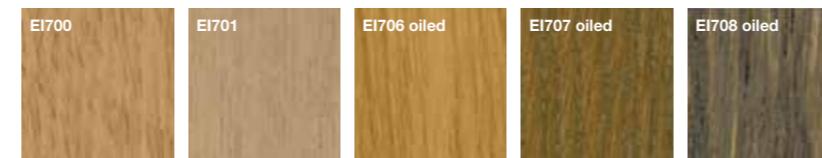

NOTES: Timber is a natural product. Each window is therefore unique. The final shade of colour is resultant of the natural timber properties and the shade of the impregnation. The more accentuated the structure, colour and surface of the timber, the more deviations from the colour samples may occur.

Special colours

The **Internorm RAL colour programme** offers a range of design options (facade quality). You can choose these colours for the exterior of the aluminium cladding and timber for the interior.

Please note that not every colour is available for every window or door.

Due to printing and manufacturing conditions, colour and structural deviations can occur between the illustrations and the original products.

Your **Internorm 1st window partner** will be able to show you the original colour samples.



Internorm

uPVC for window systems

White

uPVC white

Available for the interior and exterior of all uPVC window systems.

EXCEPTIONS: KF 310 home pure, KF 410 studio, KV 350 and KV 440 are exclusively available as uPVC-aluminium systems

	Golden oak	Brilliant white	Cream white	Dark grey
Interior Decor colours				
KF 510				X
KF 520				X
KF 310	X	X	X	X
KV 350	X	X	X	X
KF 410 studio		X		X
KF 410 home pure		X		X
KF 410 home soft	X	X	X	
KF 410 ambiente	X	X	X	
KV 440 home pure		X		X
KV 440 home soft	X	X	X	
KV 440 ambiente	X	X	X	
KS 430	X	X	X	X

I-tec Décor

Digital printing for uPVC window interior

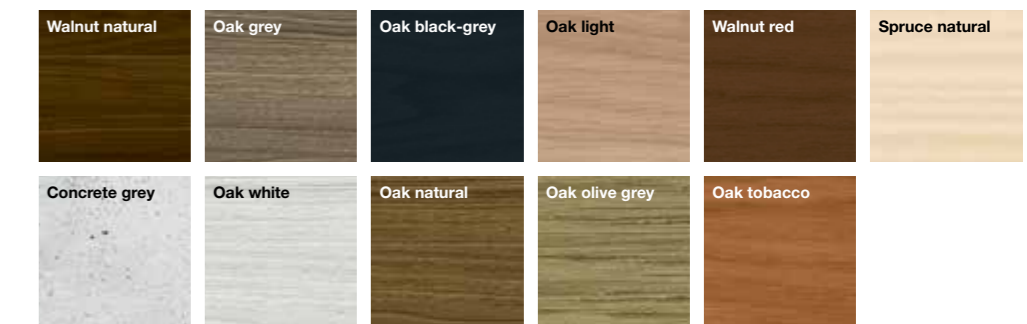

NOTE: I-tec Décor only available for KF 310, KF 410 and KS 430

Inter

Add a splash of colour to your life

Windows and doors have become design objects in their own right. Choose colour and create a focal point or seamlessly blend them into the overall architecture.

An overview of our window handle range

The Internorm window handles fit comfortably into your hand and are available as a round, square or flat option. We suggest you start by choosing the handles for your interior decor and then find a matching window handle.

Internorm handle colours

-  F1 aluminium natural
-  F9 aluminium steel
-  RAL 9010 white
-  F9714m black matt
-  Polished brass
-  Chrome with satin finish
-  Chrome/stainless steel matt
-  Brass matt/aluminium steel

NOTE: Not all handle options are available for each window system. Your Internorm distribution partner will be happy to advise you on the combinations available.

		
Lift & slide door handle G80 Shown in black matt Item No. 36133	Lift & slide door handle Dallas Shown in aluminium natural Item No. 36424	Lift & slide door handle Softline Shown in aluminium natural Item No. 32447
available colours 	available colours 	available colours 

				
Handle G80 Flat key hole cover plate Shown in aluminium natural Item No. 36435	Handle G80 Shown in aluminium natural Item No. 36404 (item No. 36505 for KF 310, KF 320, KV 350)	Handle G80 lockable Shown in aluminium natural Item No. 36400	Handle G80 with push button Shown in aluminium steel Item No. 36394	Secustik® handle G80 Shown in aluminium natural Item No. 36428
available colours 	available colours 	available colours 	available colours 	available colours 
				
Secustik® handle Austin flat cylinder key hole cover plate Shown in black matt Item No. 36170	SecuForte® Shown in black matt Item No. 36132	Secustik® handle Dallas Shown in aluminium natural Item No. 36426	Standard handle Shown in aluminium natural Item No. 33899 (item No. 36504 for KF 310, KV 350)	Handle with push button Shown in aluminium natural Item No. 33885
available colours 	available colours 	available colours 	available colours 	available colours 
				
Designer handle Bruxelles Shown in chrome satin finish Item No. 34592	Handle Amsterdam Shown in aluminium natural Item No. 36416	Designer handle Athanai Shown in brass matt/ aluminium steel Item No. 34594	Lockable handle Shown in brass Item No. 33886	Designer handle Atlanta Shown in brass Item No. 34750
available colours 	available colours 	available colours 	available colours 	available colours 

Our entire entrance door handle range at a glance

Door handles add special detail to the overall design of an entrance door. Internorm offers many options, from recessed, handle bars, to lever handles and more.

Recessed handles

Both attached and flush possible. Only attached option available for AT500, AT520 and AT525.



SG16
Recessed handle, 430x100
Stainless steel
AT500, AT520, AT525, AT530, AT540, HT400, HT410



SG13
Recessed handle, 220x125
Stainless steel
AT500, AT520, AT525, AT530, AT540, HT400, HT410



SG17
Recessed handle, 110x500
Stainless steel, black
AT500, AT520, AT525, AT530, AT540, HT400, HT410

LED lighting available for AT530 and AT540 (see p. 100)



SG18
Recessed handle, 110x1400
Stainless steel
AT500, AT520, AT525, AT530, AT540, HT400, HT410

LED lighting available for AT530 and AT540 (see p. 100)

GSIV Integrated recessed handle

GS140 406 x 59 mm

GS101 1000 x 59 mm

GS102 1200 x 59 mm

GS103 1400 x 59 mm

GSIV Variable length

Respective door panel colour or black AT500, AT520, AT525, AT530, AT540, HT400, HT410

LED lighting available for AT530, AT540, HT400, HT410



Bar handles



HGS01
Half-round bar handle
40x1000
2 supports

HGS02
40x1200
2 supports

HGS03
40x1400
2 supports

HGS04
40x1600
2 supports

Stainless steel, black
AT500, AT520, AT525, AT530, AT540, HT400, HT410



KGS01A
for ekey-dLine square handle bar
40x1000
2 supports

KGS05A
for ekey-dLine square handle bar
40x1800
3 supports

Stainless steel
AT530, AT540, HT400, HT410



KGS01
Square handle bar
40x1000
2 supports

KGS02
40x1200
2 supports

KGS03
40x1400
2 supports

KGS04
40x1600
3 supports

KGS05
40x1800
3 supports

KGS06
40x2000
3 supports

Stainless steel, black
AT500, AT510, AT520, AT525, AT530, AT540, HT400, HT410

KGS01L (not shown)
40x1000
2 supports with integrated LED lighting

KGS03L (not shown)
40x1400
2 supports with integrated LED lighting

Stainless steel AT530, AT540, HT400, HT410



RGS01
Round handle bar
Ø 30
Height 1000
2 supports

RGS02
Height 1200
2 supports

RGS03
Height 1400
2 supports

RGS04
Height 1600
3 supports

RGS05
Height 1800
3 supports

RGS06
Height 2000
3 supports

Stainless steel
AT500, AT510, AT520, AT525, AT530, AT540, HT400, HT410



EGS01
Round handle bar
Ø 35
Variable height

Stainless steel
AT500, AT510, AT520, AT525, AT530, AT540, HT400, HT410



GKV01
Square handle bar with straight ends
30x1000

GKV02
30x1200

GKV03
30x1400

GKV04
30x1600

Stainless steel, black
AT500, AT520, AT525, AT530, AT540, HT400, HT410



RSS01
Round handle bar with diagonal supports
Ø 32
Height 1000
2 supports

RSS02
Height 1200
2 supports

RSS03
Height 1400
2 supports

RSS04
Height 1600
3 supports

RSS05
Height 1800
3 supports

RSS06
Height 2000
3 supports

Stainless steel
AT500



GOK60
Handle bar
Height 600
2 supports
Stainless steel
AT500, AT520, AT525, AT530, AT540, HT400, HT410



GKV60
Handle bar
height 600
2 supports
Stainless steel, black
AT500, AT520, AT525, AT530, AT540, HT400, HT410



GPR60
Handle bar
height 600
2 supports
Stainless steel
AT500, AT520, AT525, AT530, AT540, HT400, HT410

A stylish selection of handles is available for all door series.

Please note that not all handles are available for all doors.

The pictured handles are not in proportion and this page only shows a selection of handles available.

Dimensions are indicated in mm, width x height.

Push and bracket handles



HS10
Push handle
93x400
stainless steel
AT500, AT510,
AT520, AT525,
AT530, AT540,
HT400, HT410



HS50
Push handle
109x500
stainless steel
AT500, AT510,
AT520, AT525,
AT530, AT540,
HT400, HT410



HS40
Push handle
90x500
stainless steel matt
AT500, AT510,
AT520, AT525,
AT530, AT540,
HT400, HT410



HS42
Push handle
90x500
stainless steel
AT500, AT510,
AT520, AT525,
AT530, AT540,
HT400, HT410



PB30
Tubular U-handle
100x300
stainless steel
(PB31 = aluminium
F1) AT500



HS32
Push handle
118x477
Stainless steel
(HS30 = Ring
stainless steel matt)
AT500, AT510,
AT520, AT525,
AT530, AT540,
HT400, HT410



GKN201
stainless steel
AT500

Lever



GD25
Stainless steel, black
AT500, AT510, AT520,
AT525, AT530, AT540,
HT400, HT410



PD12
Brushed aluminium
AT510, AT520, AT525,
AT530, AT540



GD10
Stainless steel
AT500, AT510, AT520, AT525,
AT530, AT540, HT400, HT410



GD15
Stainless steel, black AT500,
AT510, AT520, AT525, AT530,
AT540, HT400, HT410



GD20
Stainless steel
AT500, AT510, AT520, AT525,
AT530, AT540, HT400, HT410



GD30
Stainless steel
AT500, AT510, AT520, AT525,
AT530, AT540, HT400, HT410



SD10
Stainless steel, black
AT510, AT520, AT525, AT530,
AT540, HT400, HT410



SD15
Stainless steel (SD20 = aluminium
natural, SD25 = aluminium white)
AT500, AT510, AT520,
AT540, HT400, HT410

Interior designs for doors

Internorm

You can also create features on the inside of your entrance door - choose between our simple straight or elegantly curved designs. Available in our standard range of aluminium colours for the colour features, with either decorative trim or milled grooves. These can be contrasting, or match the colour of the door panel, making the decorative trim or milling stand out.



Interior design 1

Two flush-mounted trims in black or stainless steel frame the slim, vertical feature area.

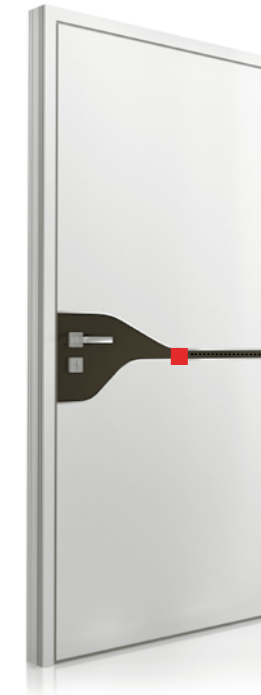
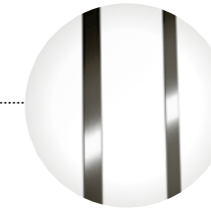

Interior design 2

The feature colour area of this elegant design, which surrounds the door handle, is set within flush-mounted stainless steel trims or milled grooves.

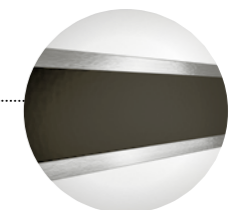

Note: Interior designs are only available for selected models of the AT 540 and AT 530 systems. Your distribution partner will be happy to advise on options.

Milled grooves and metal trims for doors

Simple or impactful. Whatever option you choose, they both offer a unique appeal. The more understated milled grooves blend into the design of your entrance door, whereas trims made of Alunox (flush) or stainless steel (raised) offer visual highlights. Black aluminium trims, available flush or raised, create effective contrast.



Milled grooves

Double milled groove



Metal trims

Metal trims are available as flush in aluminium or raised in stainless steel and black.

Double aluminium strip



Our structured glass for windows and doors



Glass is not easy to display in print and might deviate from the original in both colour and structure. To avoid confusion, please compare the sample glass at your **Internorm 1st window partner**.

Condensation – sign of quality: Internorm windows have excellent thermal insulation and air tightness. This not only prevents drafts, it also saves on heating, and keeps out noise. Due to physical conditions, condensation may occur. This might be seen as an issue, however, it is actually a sure sign that the window is performing and offers good thermal insulation properties.

Condensation on the outside: After cold nights, the glass panes can mist up on the outside because good thermal insulation ensures that very little heat escapes from the inside to the outside of the window. This means that the outer pane stays relatively cold and the ambient moisture, caused by the temperature difference between the air and the window surface, can become visible on the cool glass surface in the form of condensation (small water droplets that limit what you can see through the pane). However, this effect only occurs during morning hours and if the window is in a certain position in the house. It disappears again as soon as the temperature rises.

Condensation on the inside: Due to water vapour from kitchens, bathroom or simply breathing, particularly in bedrooms, the humidity of the air increases in interior spaces. If you do not ventilate rooms regularly, this humidity can quickly form as condensation on your windows.

You can find more tips and tricks on how to avoid condensation on our homepage and in the **“Internorm User Manual, Care, Maintenance, Warranties”**.

ESG (toughened safety glass) and insulating glass

Most insulating and toughened safety glass used in Internorm products is made in-house. We are independently driving progress and trying to meet the demand for innovative and highly insulating glass solutions.

Thermal insulation glazing

Wafer-thin stainless-steel coatings and noble gases, such as argon or krypton, are inserted into the space between the panes and provide perfect thermal insulation. If you opt for triple thermal insulation glazing instead of double glazing, you can incorporate 40% more glass areas without increasing your heating costs.

Security glass

If sufficient force is applied to ESG (toughened safety glass), it breaks into blunt-edged, loosely connected crumbs. VSG (laminated safety glass) shatters, but is attached to a tear-resistant, viscoplastic intermediate layer. The risk of injury is therefore very low.

Design glass for doors

A range of techniques such as fluted bevel, sandblasting, glass decorative trim or colour fields are used to create the design glass.



Motif glass for doors

Depending on the desired decorative element, you can decide whether the look is also repeated in the side light or in the glass feature. These feature lines continue from the door itself and are available in different options.

Please note that not every glass can be used with every system.



Clear surface area with sandblasted stripes



Sandblasted surface area with clear stripes and clear glass edges



Sandblasted surface area with clear stripes

Our online Door Designer

Every Internorm entrance door is totally bespoke and can be designed to suit your personal taste. Our online Door Designer tool lets you create your dream door at your leisure

Simple, individual, online!

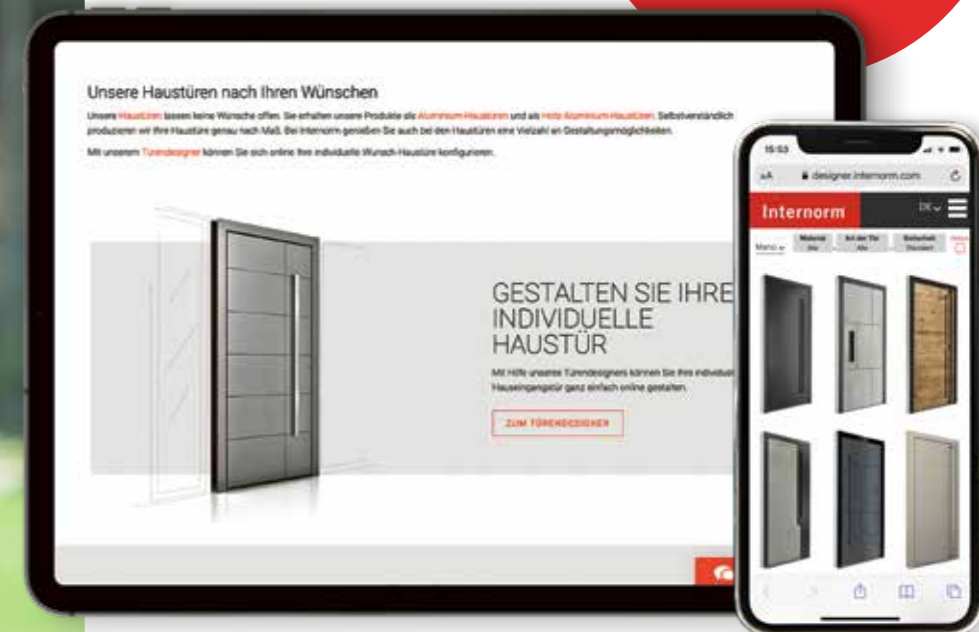
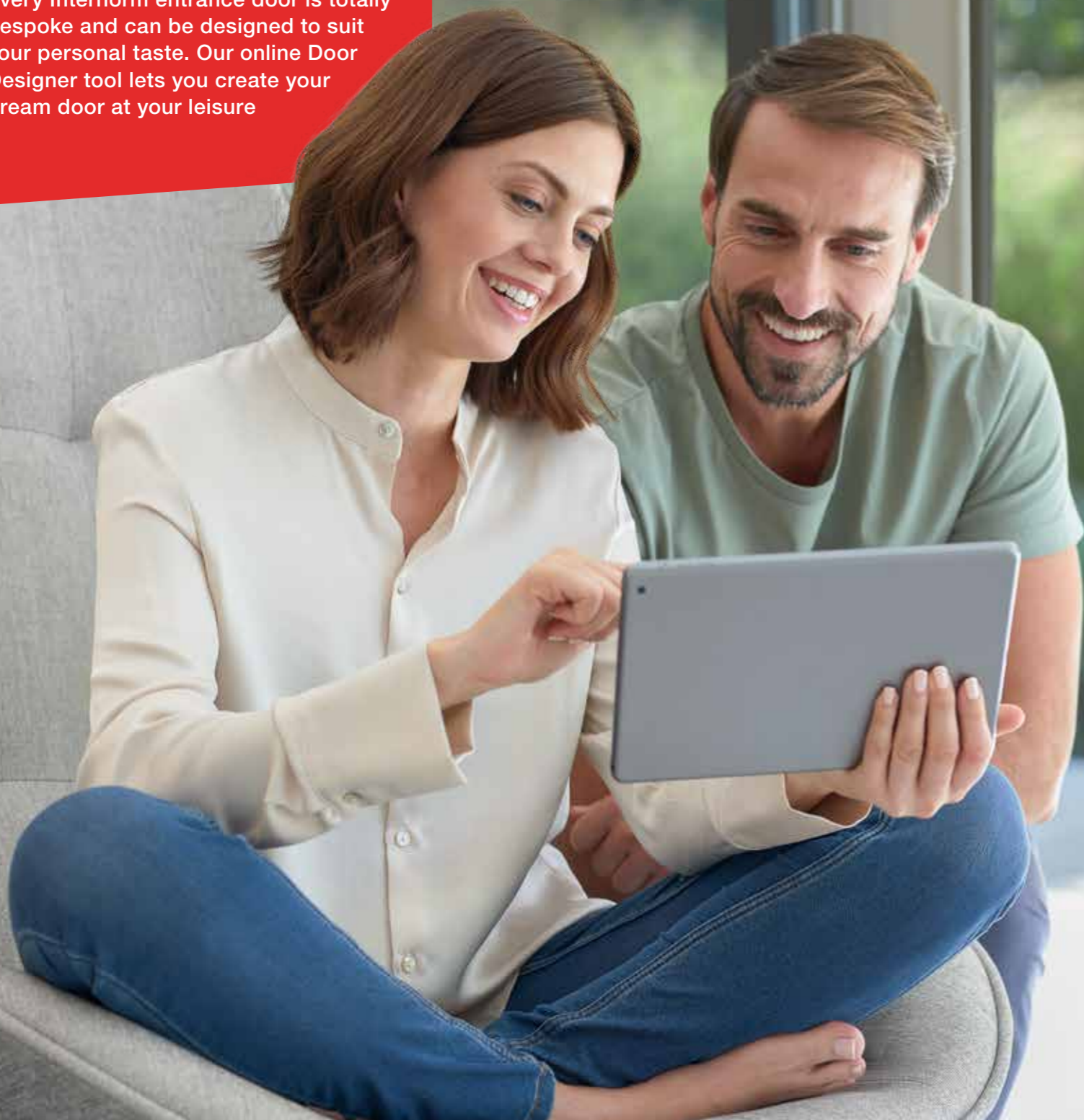

You create your very own interior design with furniture, flooring or perhaps wall coverings in different colours or materials – elegant, classic and traditional or modern. Windows and entrance doors no longer play a secondary role in designing your interior spaces. With a variety of finishes and colours to choose from, you can create a very individual living environment.

Internorm's bespoke entrance doors are available in both aluminium and timber-aluminium in a range of design options and made to your requirements.

Take advantage of our **online Door Designer tool** on our website to create your custom door, or let one of our **Internorm 1st window partners** advise you.



Try the Internorm Door Designer here!



Enjoy the benefits of a French balcony

Create a generous sense of space, even in smaller rooms.

Large-scale glazing is integral to modern architecture. Floor-to-ceiling windows and balcony doors are popular for upper floors. However, balconies or terraces are often not an option in city centres for structural reasons.

Juliet balconies are the perfect solution for letting more light into a room, providing uninterrupted views, and creating beautiful design features. Made with laminated safety glass and stainless steel trim, Internorm's Juliet balconies are factory fitted and uniquely integrated into the window or door frame. Round or square stainless steel bars are also available.

Please ensure that minimum heights comply with Building Regulations to prevent falling.

Different Juliet balcony options:



Option with round stainless-steel rail



Option with square stainless-steel rail



Glass balustrade option with laminated safety glass, including stainless steel trim

Feel safe and secure

To feel safe and secure in your own home, burglary protection, as well as maximum security for children, are fundamental requirements. Quality windows largely contribute to this feeling of safety. With effective and proven technologies from Internorm, you can protect your family and make it difficult for intruders to enter your home.



Security locks

All Internorm window systems are equipped with standard security hardware. Solid, yet discreet locking elements, together with octagonal mushroom cams in the sash, provide secure locking (except KF 510 and KF 520).



I-tec Glazing

Thanks to Internorm's patented glazing technology, the glass pane cannot be pushed out. The glass is glued into the frame all the way round, making it more secure and stable. Most Internorm window systems include I-tec Glazing as standard.



Security handle

The new Secustik® window handle contains a jamming device that provides integrated security. The patented locking mechanism offers foolproof protection against moving the lock from the outside (standard for the premium-design KF 510 and KF 520 uPVC and uPVC-aluminium windows).

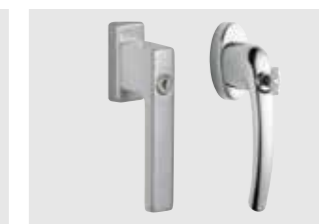

Lockable handles

The window is locked with a key and cannot be opened from the inside or outside. Lockable handles offer optimal security for children and perfect burglary protection.



I-tec Secure

The revolutionary locking technology from Internorm guarantees maximum protection. When locking the window, the flaps open and press directly into the interior part of the frame on all sides. It is virtually impossible to lever the window (for KF 510 and KF 520).



Concealed hardware

prevents windows from being levered out of their hinges, with the added benefit of making windows look neat and easy to clean.



Electric opening sensor (Handle-operated)

Discreet and reliable, these hardwired or wireless locking sensors report whether windows or French doors are open, tilted or locked.



VSG (laminated safety glass)

Unlike standard glass, laminated glass does not shatter when broken. A tough, tear-resistant interlayer, bonded between two glass panes, ensures that the glass stays in the frame and does not cause injury.

Burglar-proof as standard

Proven security locks in our entrance doors ensure that you, your family and belongings are kept safe. Tested up to resistance class RC 3, the high-quality locking systems from renowned manufacturer KfV, provide outstanding burglary protection.



Internorm

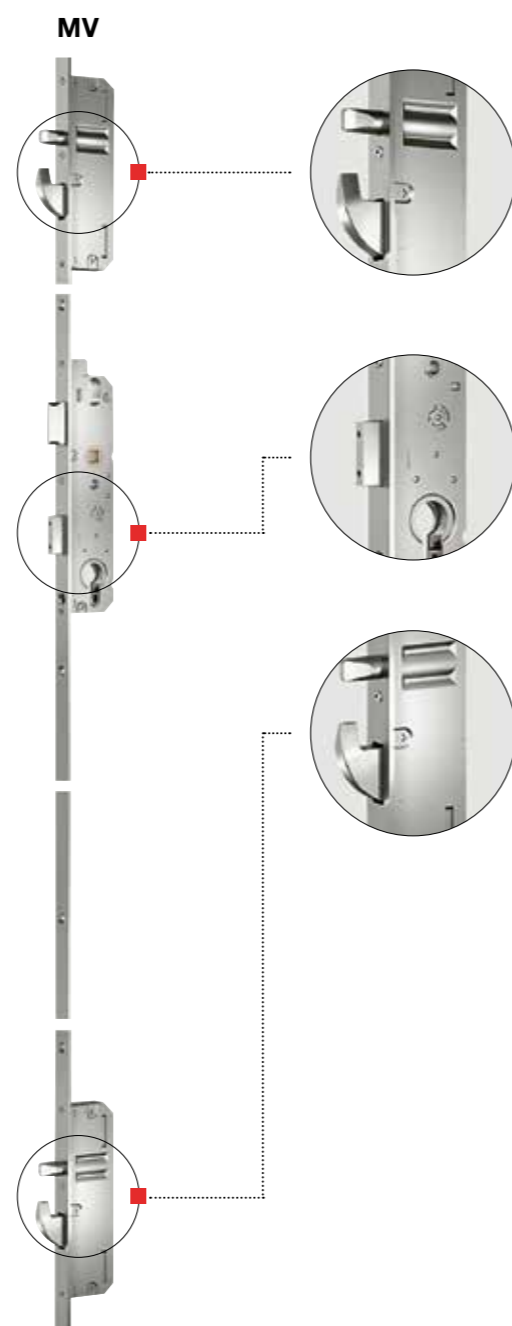

Security as standard

Mechanical: MV

Internorm entrance doors are equipped with a mechanical multi-point lock as standard.

Security as standard

- Multi-point lock = 5-fold protection through a main deadbolt, 2 steel bolts and 2 swivel latches
- 3 solid door hinges ensure high stability.
- Increased burglary protection is already provided with the standard cylinder (protection against lock picking and drilling)

Comfort as standard

- The soft-lock latch ensures easy operation as well as a gentle close, plus it doesn't require any maintenance (no oil needed)
- Three-dimensionally adjustable door hinges allow you to install the entrance door even more precisely and accurately – with mounted door sash.
- Cylinders that are lockable from both sides – meaning you can always lock them, even if a key is inserted on the other side

Enhanced security and comfort

Automatic: MVAM

Enhanced security with an automatic multi-point lock with main deadbolt, 2 trigger bolts and 2 swivel latches:

- Door mechanically locks automatically – trigger bolts and swivel latch extend through spring force
- Doesn't need to be locked with a key

Semi-motorised: EE

Comfort and security thanks to a semi-motorised multi-point lock with main deadbolt, 2 trigger bolts and 2 swivel latches:

- Door mechanically locks automatically – trigger bolts and swivel latch extend through spring force
- No need to lock or unlock with a key (unlocking through electric drive); on the inside, the door is unlocked by pressing the lever. A child lock function blocks the lever. Can be combined with all access control systems.

Fully motorised: EVE, EVC

The ultimate comfort thanks to a fully motorised multi-point lock with main deadbolt, 2 trigger bolts and 2 swivel latches:

- Door locks automatically – trigger bolts, swivel latch and main deadbolt extend automatically
- Powerful fastening torque of the door sash through the motor
- No key needed to lock or unlock the door (locking and unlocking via the electric drive). On the inside, the door unlocks either by pressing the lever (EVC) or an electric switch (EVE). From the outside, the door unlocks through access controls (e.g. finger scan, etc.).

A note on EVC: Children can also open the locked door at anytime by pressing the lever on the inside and thereby get outside. In this case, opt for an EVE with an electric button that is hidden or in a higher position.

Your finger is the key

Gone are the days of searching the whole house for your keys – thanks to a fingerprint scanner or keypad. Internorm installs these smart systems on top of or flush-mounted on the door panel, or integrates them into the handle.

For entrance doors and lift & slide doors



Finger scanner

The latest generation of **ekey dLine** fingerprint scanners conveniently replaces conventional keys. The control unit takes up little space and is securely installed on the entrance door panel or the frame of the lift & slide door. You won't have to worry about forgetting, losing or having your keys, cards or codes stolen.

Simple. Open the door with one touch of your finger. You manage your permissions yourself – no technician or computer required. All you need is the **ekey bionyx** app. **Convenient.** Your finger is the key, meaning you'll always have it "on hand". The smart software keeps learning every time you use it and recognises growth in children's fingers or user habits.

Secure. Your unique fingerprint is more secure than any key that could be lost or stolen. Manipulating the system from the outside is impossible. Unauthorised third parties cannot gain access to the key.

A scanner makes your entrance door smart. The system can be integrated into your home network via Wi-Fi, enabling countless functions such as remote opening or push notifications when the door is opened. In addition, your finger scanner will always have access to the latest firmware updates and therefore meet the highest security standards.

For entrance doors



For entrance doors



Keypad

On top of the finger-scanning option, you can also use the more traditional method of entering a code into the keypad. The **ekey home integra keypad** is installed directly in the door panel, so merely the ultra-flat decorative element remains visible.

With this method, you open the door by typing in a freely selectable four to ten-digit code. You can even create a pattern on the touch-sensitive screen, in the same way that many users unlock their smartphones.

You can programme up to 99 codes. This means that every user can have their own access code. This comes in handy when granting access to cleaning staff, for example – you can delete their code at any time and replace it with a new one.



Security with Winkhaus cylinders for windows and doors

You have a wide range of additional components to choose from, such as high-security cylinders, door locks and many more. Find out more from your **Internorm 1st window partner**.



Sample images

The **standard cylinder** features protection against lock picking and drilling by means of steel pins. It can be locked from both sides, meaning you can still lock and unlock the door if there is a key inserted on the other side.

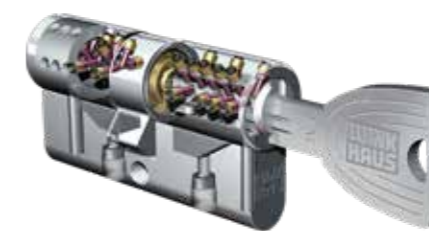

The **high-security cylinder** with three-dimensional, patented protection against lock picking and drilling, as well as pulling and tearing. The large, special key shape makes it easy to lock and prevents the key from bending or breaking. It is lockable from both sides. The symmetrical reversible key is easy to insert into the cylinder.



Every high-security cylinder comes with a personal **security card**. It serves as important proof of legitimacy for follow-up orders of cylinders or keys.

Additional entrance door security options



The **door opening restrictor TSH** serves as a secure opening limiter. You can operate it via the main lock (no cylinder on the outside). The feature is activated from the inside using a turn knob.



For the **electric door opener/ETOE** (normal function), the door can only be opened while there is contact (button is pressed, no permanent contact).

Sun protection and flyscreens

Mix & match, integrated and with many options



By adding sun protection and shade and flyscreen systems to your windows and doors, you can create a more comfortable home, and enhance the façade of your building.

Windows with integrated blinds: integrated sun protection and privacy screen between accessible panes – with the option of Venetian, Roman or Duette® blinds, and available with solar powered I-tec Shading on request.

Internal blind: this is mounted onto the window sash and is covered by a housing.

Raffstore Venetian blind: optimum control of light and solar gain with adjustable aluminium slats. Available with RETROLUX daylight control on request; can be combined with flyscreens. Ideal for lift & slide doors.

Exposed Raffstore Venetian blind: optimal control and steering of light and warmth through adjustable slats; can be combined with flyscreens.

External and mini external shutters: loose or fully mounted on the window; can be combined with flyscreens.

Flyscreens: available as fixed, turn, sliding or pull-down flyscreen. Can be combined with blinds.

Pleated flyscreen: space-saving and perfect retrofit solution, also suitable for lift & slide doors.

Window shutters: made of aluminium, with many design options; can be combined with flyscreens.

Raffstore external blinds

Avoid overheating. Reduce costs.

Did you know that smart controlled raffstores can reduce room temperature in summer by up to 10°C compared to unshaded rooms?

Particularly on south-facing rooms it is important to include shading to large areas of glazing to avoid overheating during the summer months. Modern raffstore systems can be integrated into Smart Home systems and help to control solar radiation and light transmission, therefore contributing to passive cooling in summer and solar heating in winter.

Up to 50% less cooling energy

Did you know that cooling a room by 1°C with air conditioning uses three times more energy than increasing heating by 1°C.

Up to 30% less energy consumption

Smart controlled raffstores considerably reduce energy consumption by passive cooling and solar heating.

Reduce electricity costs by up to 80% by not using artificial lighting

Raffstore allow you to control the amount of sun entering your home and the specially designed slats effectively direct daylight into the interior.

Up to 8.5 tonnes of CO₂ saved

One raffstore can save about 8.5 tonnes of CO₂ in its lifetime. The manufacture, use and disposal of a raffstore only creates around 150kg of CO₂.



Colours for sun protection

Venetian blind slats

Standard

RAL 9016 Traffic white	RAL 7035 Light grey	RAL 1015 Light ivory	Beige	RAL 9006 White aluminium
RAL 9007 Grey aluminium	RAL 7016 Anthrazite grey	DB 703 Grey	RAL 9005 Jet black	

Standard longer delivery

RAL 7038 Agate grey	RAL 7039 Quartz grey	RAL 7006 Beige grey	RAL 7021 Black grey	RAL 7022 Umbra grey
Light bronze Classic 32	Medium bronze Classic 33	Dark bronze Classic 34	RAL 6005 Moss green	

Roller shutter

white	grey	beige	cream	Grey aluminium
Aluminium-natural	DB703 Aluminium-grey	Aluminium-anthrazite grey	Aluminium-deep black	Aluminium-brown
Aluminium-moos green	Aluminium-wood dark			

Integrated & internal blinds (Venetian)

0205 milk	0152 crystal	0605 sapphire	0958 moonstone	7010 silver	7113 aluminium	4448 cream	4449 cortina
5056 burgundy red	4808 topaz	4768 praline	4161 messina	4049 genua	4249 torino	2263 indigo	2371 gentian blue
3763 fern green	3251 fir						

Duette®

2340 cloud	2342 dolphin grey	2345 fog	2341 winter white	2346 oyster	2327 dark blue	2337 royal red
------------	-------------------	----------	-------------------	-------------	----------------	----------------

Venetian blind

E001 white	E819 cream	E831 melon	E800 yellow	E802 orange	E839 kiwi	E811 light blue	E816 grey
------------	------------	------------	-------------	-------------	-----------	-----------------	-----------



Technical overview – window

Internorm

uPVC



KF 310 **KF 320** **KF 410** **KF 510** **KF 520**

Thermal insulation in W/(m²K)					
Standard coating	U _w = 0,76	U _w = 0,72	U _w = 0,71	U _w = 0,71	U _w = 0,70
Optimum value	U _w = 0,69	U _w = 0,65	U _w = 0,62	U _w = 0,63	U _w = 0,63
Noise reduction (in dB)	33 – 45	34 – 45	34 – 47	34 – 46	33 – 46
Security up to	RC 2	RC 2	RC 2	RC 3	RC 3
Locking	Concealed	Concealed	Concealed	I-tec Secure	I-tec Secure
Measurements in mm					
Frame construction depth	71	71	90	90	90
Sightline – frame/sash	107	97	113	95	85
Sightline – flying mullion (two sashes)	119	100	133	100	96
Sightline – mullion (2 sashes)	170	154	187	147	148
Designs					
Fixed	X	X	X	X	X
Turn and Tilt & Turn	X	X	X	X	X
Tilt	X	X	X	X	X
Sliding window	X	X	X	X	X
Lockable doors	X	X	X	X	X
Lift & Slide doors	X	X	X	X	X
Doors with low threshold	X	X	X	X	X
Outward opening doors	X		X	X	
Gaskets					
Anzahl	3	3	3	3	3
Farbe Anschlagdichtung außen	Light grey	Light grey	Light grey	Light grey	Light grey
Georgian bars					
Integrated	X	X	X	X	X
Surface-mounted	X		X	X	
Available in Design Styles					
	home soft ambiente	studio	home pure home soft ambiente	home pure	studio
More info on page	50	48	46	44	42

uPVC-Aluminium



KF 310 **KF 320** **KF 410** **KF 510** **KF 520** **KV 350** **KV 440**

Thermal insulation in W/(m²K)							
Standard coating	U _w = 0,76	U _w = 0,72	U _w = 0,71	U _w = 0,72	U _w = 0,70	U _w = 1,0	U _w = 0,77
Optimum value	U _w = 0,69	U _w = 0,65	U _w = 0,62	U _w = 0,64	U _w = 0,63	U _w = 0,79	U _w = 0,64
Noise reduction (in dB)	33 – 45	34 – 45	34 – 47	34 – 48	33 – 46	38 – 44	39 – 45
Security up to	RC 2	RC 2	RC 2	RC 3	RC 3	RC 2	RC 2
Locking	Concealed	Concealed	Concealed	I-tec Secure	I-tec Secure	Concealed	Concealed
Measurements in mm							
Frame construction depth	74	74	93	93	93	74	93
Sightline – frame/sash	107	97	113	95	85	112	118
Sightline – flying mullion (two sashes)	119	100	133	100	96	130	144
Sightline – mullion (2 sashes)	170	154	187	147	148	181	198
Designs							
Fixed	X	X	X	X	X		
Turn and Tilt & Turn	X	X	X	X	X	X	X
Tilt	X	X	X	X	X	X	X
Sliding window	X	X	X	X	X		
Lockable doors	X	X	X	X	X		
Lift & Slide doors	X	X	X	X	X		
Doors with low threshold	X	X	X	X	X	X	X
Outward opening doors	X		X	X			
Gaskets							
Anzahl	3	3	3	3	3	3	3
Farbe Anschlagdichtung außen	Light grey/black	Light grey/black	Light grey/black	Light grey/black	Light grey/black	Light grey/black	Light grey/black
Georgian bars							
Integrated	X	X	X	X	X	X	X
Surface-mounted	X		X	X		X	X
Available in Design Styles							
	home pure home soft ambiente	studio	studio home pure home soft ambiente	home pure	studio	home pure home soft ambiente	home pure home soft ambiente
More info on page	50	48	46	44	42	67	66

Timber-Aluminium



HF 410 **HF 510** **HF 520** **HV 450**

Thermal insulation in W/(m²K)				
Standard coating	U _w = 0,71	U _w = 0,72	U _w = 0,78	U _w = 0,97
Optimum value	U _w = 0,64	U _w = 0,65	U _w = 0,71	U _w = 0,62
Noise reduction (in dB)	33 – 46	35 – 47	35 – 47	39 – 46
Security up to	RC 2	RC 2	RC 2	RC 2
Locking	Concealed	Concealed	Concealed	Concealed
Measurements in mm				
Frame construction depth	85	85	90	85
Sightline – frame/sash	108	99	101	108
Sightline – flying mullion (two sashes)	124	106	109	124
Sightline – mullion (2 sashes)	173	156	181	173
Designs				
Fixed	X	X	X	
Turn and Tilt & Turn	X	X	X	X
Tilt	X	X	X	X
Sliding window	X	X		
Lockable doors	X	X	X	
Lift & Slide doors	X	X		
Doors with low threshold	X	X	X	X
Outward opening doors	X			
Gaskets				
Anzahl	3	3	3	3
Farbe Anschlagdichtung außen	black	black	black	black
Georgian bars				
Integrated	X	X	X	X
Surface-mounted	X	X		X
Available in Design Styles				
	studio home pure home soft ambiente	home pure	studio	home pure home soft ambiente
More info on page	60	58	56	68

Technical overview – entrance doors

Lift & slide doors and fixed glazing



KS 430 HS 330 HX 300

Thermal insulation in W/(m²K)			
Standard coating	U _w = 0,68	U _w = 0,73	U _w = 0,74
Optimum value	U _w = 0,64	U _w = 0,73	U _w = 0,74
Noise reduction (in dB)			
	33 – 43	32 – 40	34 – 47
Security up to			
	RC 2	RC 2	–
Locking			
	–	–	–
Measurements in mm			
Frame construction depth	200/203	209	100
Sightline – frame/sash	169	178	108
Sightline – flying mullion (two sashes)	173	222	–
Sightline – mullion (2 sashes)	–	–	91,8/111,8
Designs			
Fixed		X	X
Turn and tilt & turn			X
Tilt			X
Sliding window			
Lockable doors	X	X	X
Lift & Slide doors			
Doors with low threshold	X	X	X
Outward opening doors			
Gaskets			
Colour external gasket	Light grey/black	black	
Georgian bars			
Integrated	X	X	
Surface-mounted	X		
More info on page			
	72	73	74



Material	Aluminium	Aluminium	Aluminium	Aluminium	Aluminium	Aluminium	Timber-Aluminium	Timber-Aluminium
Design	Flush inside and outside	Square-edged on inside and outside	Square-edged on inside, flush-mounted on outside	Contoured on inside, square-edged on outside	Contoured on inside, square-edged on outside	Contoured on inside and outside	Flush inside and outside	Square-edged on inside and outside
Thermal insulation in W/(m²K)	U _b up to 0,75	U _b up to 0,69	U _b up to 0,87	U _b up to 0,80	U _b up to 0,95	U _b up to 0,87	U _b up to 0,55	U _b up to 0,67
Noise reduction in dB	Up to 35	Up to 34	Up to 30	Up to 32	Up to 38	Up to 40	Up to 34	Up to 34
Security	Up to RC 2	Up to RC 2	Up to RC 2	Up to RC 2	Up to RC 2	Up to RC 3	Up to RC 2	Up to RC 2
Locking	Multi-point locking	Multi-point locking	Multi-point locking	Multi-point locking	Multi-point locking	Multi-point locking	Multi-point locking	Multi-point locking
Profile construction depth in mm	93	93	93	93	93	93	121	85
Gaskets	3	3	3	3	3	3	3	3
Threshold	Thermally broken	Thermally broken	Thermally broken	Thermally broken	Thermally broken	Thermally broken	Thermally broken	Thermally broken
Insulation	3-chamber frame profile, insulating foam core	3-chamber frame profile, insulating foam core	3-chamber frame profile, insulating foam core	3-chamber frame profile, insulating foam core	3-chamber frame profile, insulating glass core	3-chamber frame profile, insulating glass core	Thermal foam insulation	Thermal foam insulation

National and international certifications affirm the high quality of our products.

Internorm's wealth of experience and focus on innovative technical solutions ensure that you receive the best product and service. State-of-the-art production facilities and stringent quality controls ensure that our product sets industry standards. Prestigious awards and certifications from leading European test institutes support this.



Austrian coat of arms



Austria quality mark



TUV ISO 9001



TUV ISO 14001



RAL quality mark



Technische Universität Graz

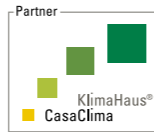

KlimaHaus-Zertifikat



Minergie® certificate



Austrian Society for Environmental Engineering



Certificate for products from sustainable forestry



MADE IN AUSTRIA



Energy Globe (Project Schiesthaus)



VinylPlus-Zertifikat



Passive House Institute



reddot winner 2023

IMPRINT

Publisher: Internorm International GmbH, Ganglgutstraße 131, A-4050 Traun
Photos: Studio Hoflehner, A-4600 Wels | studio46, A-4863 Seewalchen am Attersee | EOS Werbefotografie, A-4020 Linz
 Bernhard Hörtnagl, A-6020 Innsbruck | Internorm International GmbH, A-4050 Traun
Design and litho: Internorm International GmbH, A-4050 Traun
Print: Hague Group, Leicester, LE19 4SD

Subject to technical changes, printing and typesetting errors.
 Internorm International GmbH is an ARA licence partner: Our licence number is 4477.

HEAD OFFICE

Internorm Windows UK Ltd

Unit D · Colindale Business Park
2–10 Carlisle Road · London, NW9 0HN
Tel.: +44 (0) 208 205 9991
Email: office@internorm.co.uk

uk.internorm.com
commercial.internorm.com

